

SINGLE PHASE ELECTRIC HEATED MODELS ONLY

GUARDIAN GR AND GS COMMERCIAL AIR CURTAIN RANGE WITH SIGNAL PRO CONTROLLER



INSTALLATION MANUAL

BS EN ISO 12100:2010 Safety of machinery.

BS EN 60204-1:2018 Safety of machinery. Electrical equipment of machines.

BS EN 55014-1:2017 Electromagnetic compatibility.

BS EN 60335-2-30:2009+A11:2012 Safety.

Electrical Equipment (Safety) Regulations 2016

Electromagnetic Compatibility Regulations 2016



Please read this document carefully before commencing installation, commissioning and/or servicing.
Leave it with the end user/site agent to be placed in their premises technical file after installation.

WARNING

Improper installation, adjustment, alteration, service or maintenance can cause property damage, injury or death.

All work must be carried out by appropriately qualified persons.

The manufacturer does not take any responsibility in the event of non-observance of the regulations concerning the connection of the apparatus causing a dangerous operation possibly resulting in damage to the apparatus and/or environment in which the unit is installed.

Contents

General Information (G)

Guardian air curtain range	4
General product information.....	4
Health and safety	4
Requirements	5
Clearance distances	5
Electrical	5
Important notice to installers	5
Using this manual	5

Technical Data (TD)

Technical data	6
Fuses	6
Dimensions. GS Surface mounted models ...	7
Clearance distances	7
Dimensions. GR Recessed models.....	8
Clearance distances	8
Signal Pro display panel dimensions	9
Component layout	10

Installation (I)

Installation	11
Mounting	11
Electrical supply.	11
Installation process	12
Suspending on drop rods	13
Wall mounting bracket	13
Signal Pro display panel.....	14
Optional wiring.....	15
Networking.....	15
Wiring diagram.....	16

Control panel operation (C)

Introduction.....	17
Networking.....	17
Air curtain addressing	17
Keypad buttons	18
Keypad display.....	18
Operation	18
User operation	19
1. Set operating mode	19
2. All off mode	19
3. All auto mode	19
4. All on mode	19
5. All heat off	19
6. Set door open temperature.....	19
7. Set heat on/off	20

8. Set overtime	20
9. Set time and days	20
10. Set time program.....	20
11. Menu end	20
Engineers instructions	21
1. Set door open fan speed	21
2. Set door closed fan speed.....	21
3. Set door closed temperature.....	21
4. Set outside temperature operation.....	21
5. Set temperature limits.....	22
6. Set int/ext timer	22
7. Set group interlocks.....	22
8. Display hours run.....	23
9. Set language	23
10. Reset connected air curtain address list ...	23
11. Reset panel to factory defaults.....	23
12. Engineers menu end.....	23
Diagnostics	24
Electric air outlet temperature when “outside limit” is set	25
Modbus protocol	26
Modbus address	26
Modbus function codes supported.....	26
Function arguments register.....	27

Maintenance and servicing (MS)

Maintenance and servicing.....	28
Inlet foam filter replacement GS.....	28
Inlet foam filter replacement GR	29
Honeycomb outlet replacement	29

Fault Finding (FF)

Fault finding.	30
General.....	30
Signal Pro fault codes.....	31

Spare Parts (SP)

Spare parts.	32
General.....	32

Parts Replacement (PR)

Parts replacement.	33
Control panel	33
Heating element	33
Fan deck.....	33

G

Guardian air curtain range

General product information

Two models

- GS Surface mounted model
- GR Recessed mounted model

Three sizes

- 1000mm
- 1500mm
- 2000mm

All electrically heated

The new design allows for quick and easy access to the control panel and the installers terminal block, the GS range has two access panels on the 1000, three on the 1500 and four on the 2000. The GR has hinged access panels which can be removed with ease

These models require a single phase (230v) electrical supply.

All units have fans capable of providing standard and high capacity air duties.

Units are designed for versatile installation, options of wall mounted, recessed within a false ceiling, fitted in a bulkhead, or on drop rods in front of glass fronted entrances.

A wall mounting bracket is available as an optional extra. Units can be mounted adjacent to each other to cover the full door opening across wider entrances.

All models are supplied with a Signal Pro display / program panel and 10m length of RJ45 communication cable. A 100m cable is available at an additional cost.

The display / program panel allows the user to control either a single air curtain, or a network of up to 16 air curtains.

Easy programming - the end users simply select whether they require the heat on or off, the required fan setting (1,2 or 3 speed), and the outlet temperature setting

Options for BMS compatibility via Modbus - communication can be linked to optional external thermostat for proportional control in various set temperatures

Health and safety

Before installing, carefully read the instructions and follow the processes explained by the manufacturer

Check that the temperature ranges given and those of the location match. The appliance must be powered with a voltage corresponding to the value shown on the rating plate.

Ensure that anchoring points are suitable for the weight and loading of the product and if required, add suitable reinforcement to the anchoring points area.

Installing, programming, commissioning, and maintenance of these products must only be carried out by suitably qualified and trained technicians and in full compliance of all applicable regulations and current best practices.

Due consideration should be taken for workplace safety, risk assessments and waste disposal.

Any modification of the product may be hazardous and the manufacturer is not liable for any damage or injury caused by improper use

Requirements

Clearance distances

For installation and maintenance clearances, please see the information on page 8 for the GS models and page 9 for the GR models.

Electrical

For full electrical loadings, please refer to the technical data section on page 6 of this manual.

It is recommended that the electrical supply to the base unit in the air curtain is via an appropriate switched isolator, fitted in accordance with the regulations in force in the country of use and must be via a fused isolator having a contact separation of greater than 3mm in all poles.



For safety reasons a good earth connection must ALWAYS be made to the heater and control box.

Models have a supply requirement of 230V 1 phase, neutral and earth. Maximum cable inlet size is 10mm².

The display / program panel is wired to the control base unit via a RJ45 pre-wired cable.

Networked air curtain interconnects via a RJ45 pre-wired cable

Important notice to installers



Before installation, check the local distribution conditions, supply voltage are compatible.



Installation, assembly, commissioning, service and maintenance procedures must be carried out only by suitable competent qualified persons. Unauthorised modifications to the appliance, or departure from the manufacturer's guidance on intended use, or installation contrary to the manufacturer's recommendations may constitute a hazard.

Note

To ignore the warning and caution notices, and to ignore the advice from the manufacturer on installation, commissioning, servicing, or use, will jeopardise any applicable warranty, such a situation could also compromise the safe and efficient running of the appliance itself, and thereby constitute a hazard.

Using this manual

Contained within the text of the manual, the symbols for 'Caution' and 'Warning' these are used to highlight certain points.



Caution is used when failure to follow or implement the instruction(s) can lead to premature failure or damage to the heater or its component parts.



Warning is used when failure to heed or implement the instruction(s) can lead to not only component damage, but also to a hazardous situation being created where there is a risk of personal injury.

Technical data

TD

Data	Fan speed	Unit	1000E-1PH	1500E-1PH	2000E-1PH
All models					
Maximum door width	L, M, H	m	1.0	1.5	2.0
Maximum mounting height standard capacity	L, M	m	3.0		
Maximum mounting height high capacity	H	m	4.0		
Maximum air volume	L	m ³ /h	1150	1730	2300
	M	m ³ /h	1440	2270	2880
	H	m ³ /h	1800	2700	3600
Maximum velocity at 0 metre	L	m/s	6.4		
	M	m/s	8	8.4	8
	H	m/s	10	10.1	10
Maximum velocity at 1 metre	H	m/s	5.6	5.2	5.4
Maximum velocity at 2 metre	H	m/s	3.8	3.5	3.7
Maximum velocity at 3 metre	H	m/s	2.8	2.5	2.8
Motor power	L, M, H	W	365	530	730
Noise level @ 3m free field	L	dB(A)	52		
	M	dB(A)	55		
	H	dB(A)	59		
Program panel control wiring			RJ45 (pre-wired cable required)		
Low voltage cable terminal size			1.5mm ² MAX		
Electric Heat					
Electrical supply	L, M, H		230V 1 phase 50Hz		
Heating capacity	L, H	kW	6	6	8
Total electrical load (Maximum)		A	28.9	28.9	37.6
Max temperature rise	L	°C	14	9	9
	M	°C	11	7	7
	H	°C	9	6	6
Weight		kg	34.5	52	64.5
External fuse size (D type MCB)	H	A	32	32	40

Table 1 Technical data

Fuse

Guardian air curtain control is fitted with a T1H (1A) 5mm x 20mm control circuit fuse.

Dimensions. GS Surface mounted models

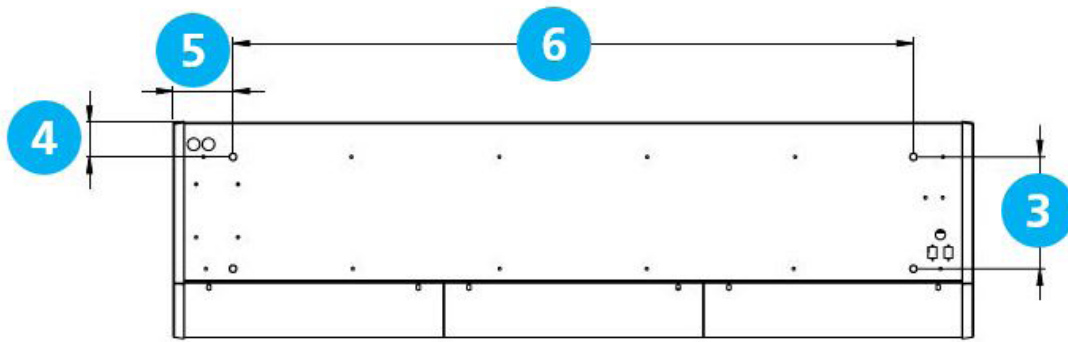

Figure 2 GS Top view

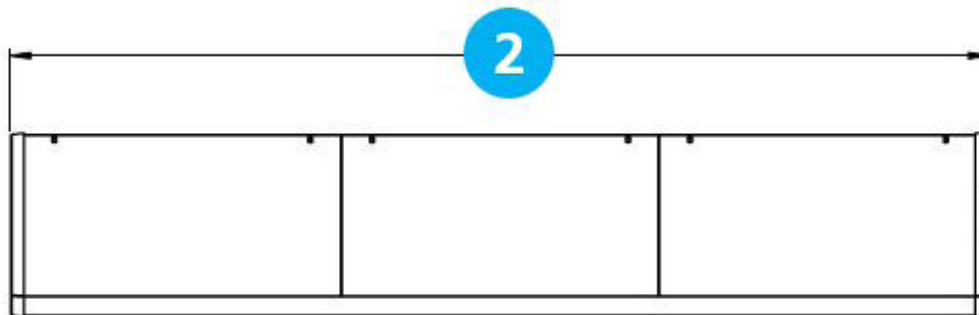

Figure 2.1 GS Front view

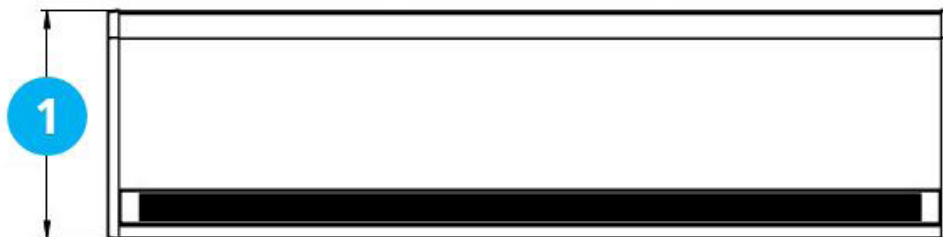

Figure 2.2 GS Bottom view

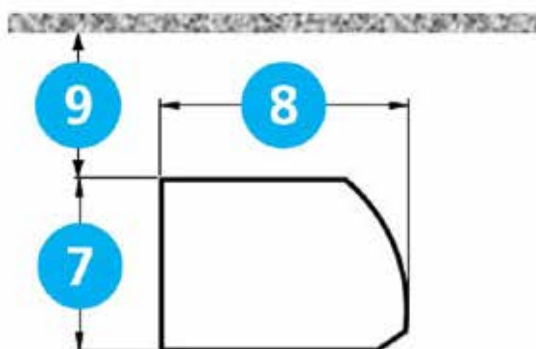

Figure 2.3 GS Side view

Reference	GS 1000	GS 1500	GS 2000
1	440		
2	1094	1620	2148
3	227		
4	70		
5	132	130	132
6	830	1360	1884
7	306		
8	440		
9	>100		

Table 2 GS dimensions

Clearance distances

It is recommended that a minimum clearance of 100mm is allowed around the top and front of the unit. The clearance allows for cable entry and prevents combustible surfaces overheating.

The minimum mounting height (floor to grille outlet) is 1.8m. The recommended maximum mounting height is 3m for standard fan setting & 4m for high

Dimensions. GR Recessed models

TD

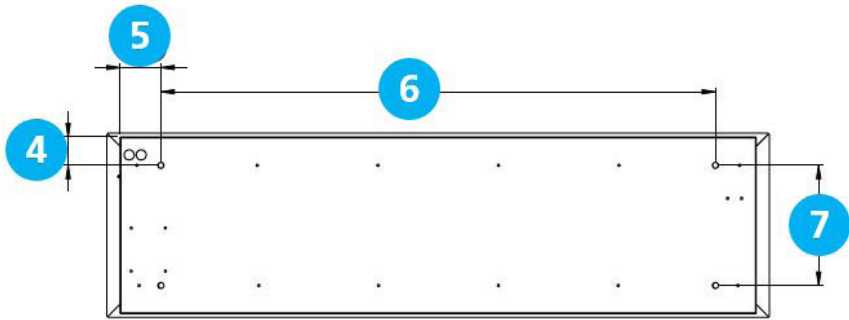

Figure 3 GR Top view

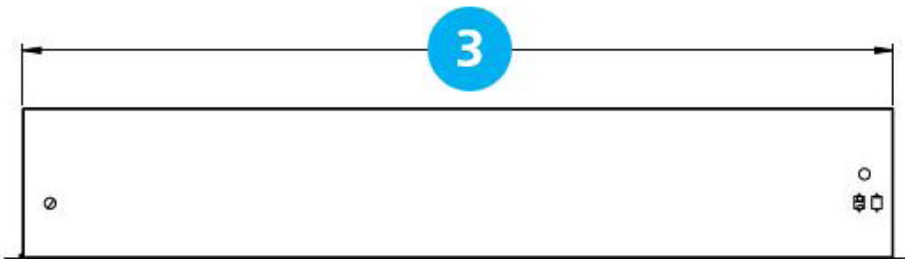

Figure 3.1 GR Front view

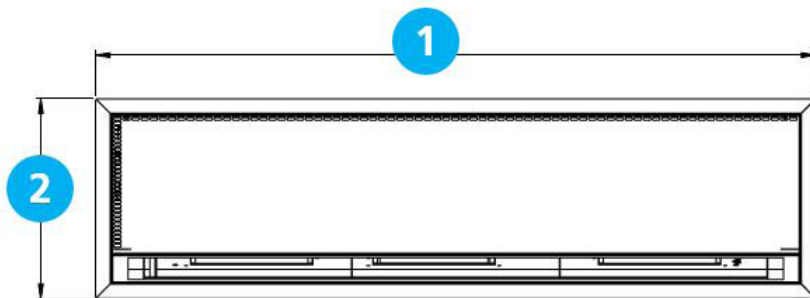

Figure 3.2 GR Bottom view

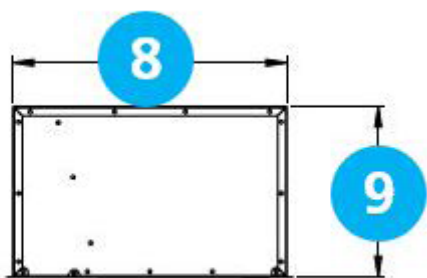

Figure 3.3 GR Side view
Clearance distances

Reference	GR 1000	GR 1500	GR 2000
1	1125	1650	2177
2	457		
3	1060	1584	2111
4	70		
5	114	112	114
6	830	1360	1884
7	298		
8	438		
9	273		

Table 3 GR dimensions

It is recommended that a minimum clearance of 100mm is allowed around the case. The clearance allows for cable entry and prevents combustible surfaces overheating.

The minimum mounting height (floor to grille outlet) is 1.8m. The recommended maximum mounting height is 3m for standard fan setting & 4m for high.

Signal Pro display panel dimensions

The Signal Pro display panel is supplied with an industry standard plastic double surface mounted socket box. Alternatively, the display panel can be flush mounted using a customer supplied plastic or metal flush conduit box as shown in Figure 5.2

TD



Figure 5 Surface mount box

Figure 5.1 Flush mounting plastic conduit box (by others)

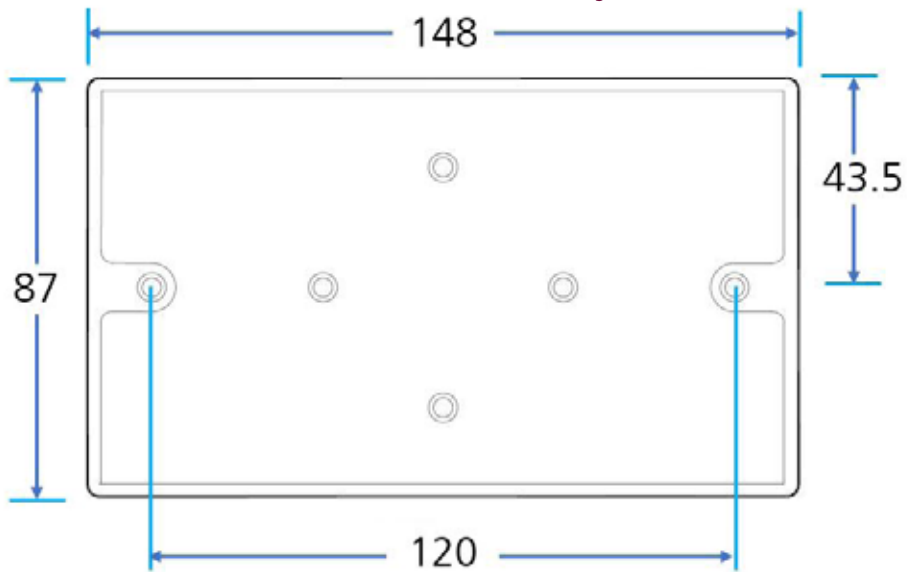

Figure 5.2 Surface mounting back box dimensions

Component layout

TD

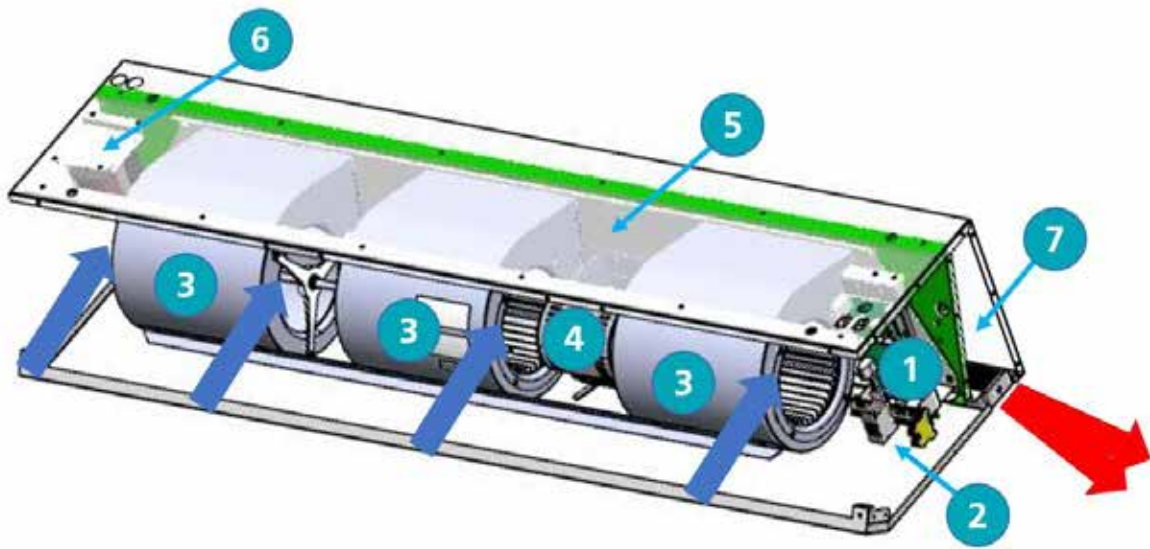

Figure 6 Component layout GS

Location	Component
1	Control panel
2	Installer terminal block
3	Fan
4	Fan motor
5	Fan deck
6	Resistor (1500 only)
7	Heating element

Table 5 GS & GR components

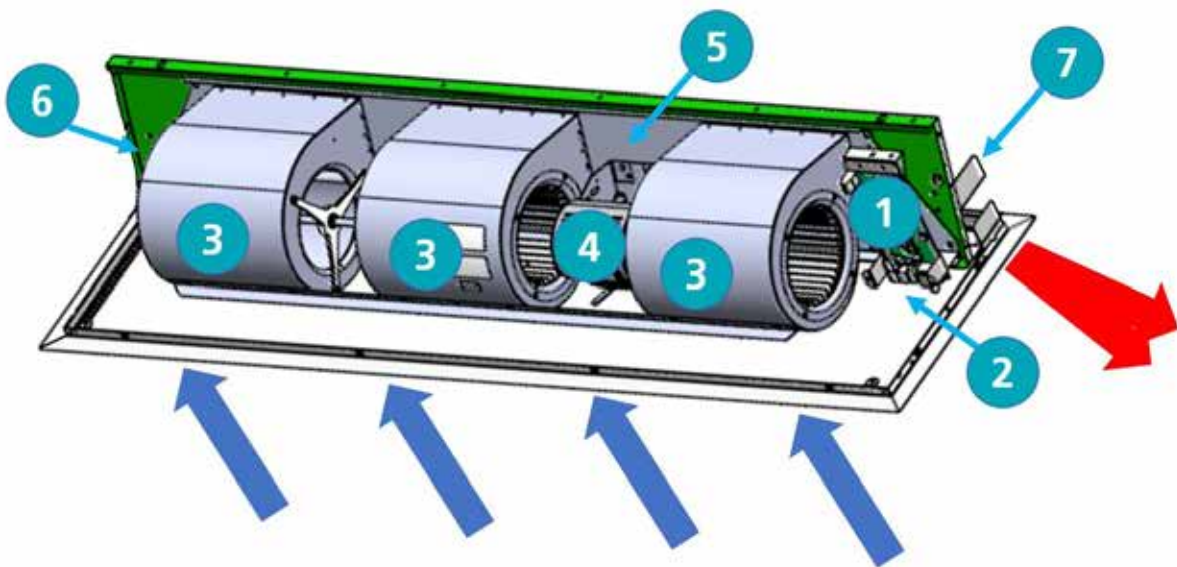

Figure 7 Component layout GR

Installation

Mounting

Guardian GS and GR air curtain units are designed to be installed horizontally directly over the door opening on the inside of the building, against a wall or ceiling.



Care must be taken to allow complete free air movement into the inlet grilles of the unit to ensure the correct working operation of the air curtain. The honeycomb outlet should be as close to the top of the door as possible and can be angled towards the door from 0° to -5°. Ensure to cover the entire door width. See figure 8

Units can be mounted adjacent to each other to cover the full door opening across wider entrances.



The GS units are designed for surface mounting and should not be placed into a ceiling void, due to possible obstruction of airflow and difficulty in routine cleaning and maintenance. Use the GR for these types of applications



It is the sole responsibility of the installer to ensure that the points of attachment to the building are sound.



Verification with the consultant/ architect or owner of the building is recommended to ensure that a sound, stable installation can be achieved.

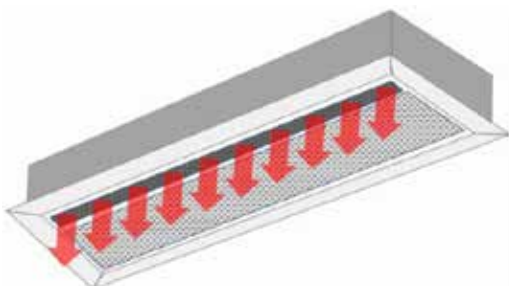

Figure 8 Honeycomb outlet position near to the door adjustable angle of 0 to -5°

Electrical supply.

Units require a connection to 1 phase 230V power supply only.

1000 and 1500 models consume 6kW and 2000 models consume 8kW.

The appliance must be connected to the supply via an appropriate a switched fused isolator, having a contact separation of greater than 3mm. See technical data for fuse rating on page 6

Once the covers have been removed, the installation engineers terminal block is located to the right hand side of the unit. This terminal block is used for the connection of the mains supply and additional controls, for example door switch. Wire in accordance to the diagram in the wiring section, on page 17



For safety reasons, a sound earth connection must always be made to the unit before it is put in to use. The unit should be wired in accordance with IEE Regulations for the Electrical Equipment of Buildings.



The display panel is connected to the control panel (base unit) via a pre-wired RJ45 cable maximum length of 100m. (10m supplied as standard). It is recommended that this cable is run separately within its own trunking to avoid external interference.

Installation process

1. Remove all packaging and covers

Note All outer metal surfaces are covered by a protective plastic film, which must be removed before final fixing and operation of the unit.

2. GS units, Loosen (DO NOT REMOVE) the screws in the top of each front inlet cover [1] (see figure 9.1 and 10 dog bone slot) then slide the left cover to the left [2] which will allow the cover to slide under the end cap. This will allow the next cover to be pushed to the left [3] (see figure 9.1) allowing it to be released from the screw slot [4] by pulling forward and lifted upwards out of the lower groove in the case.
3. The first cover can then be pushed to the right to release it from the screw slot, (see figure 10) then pull forward and lift upwards to be removed. For additional covers fitted on the 1500 or 2000 units loosen the fixing screws and remove as with the previous covers.

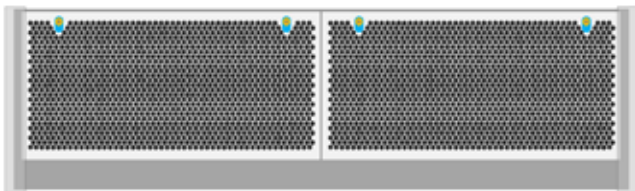

Figure 9 GS cover fixing point

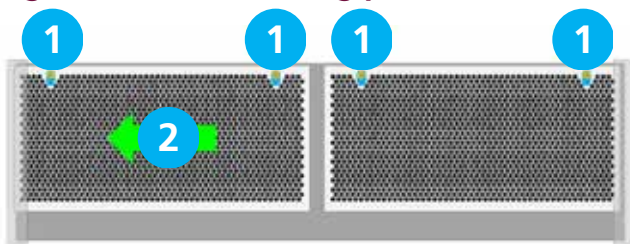

Figure 9.1 GS cover fixing point

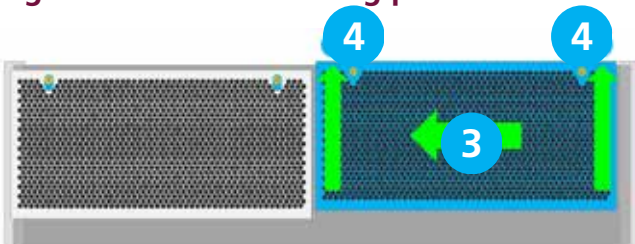

Figure 9.2 GS cover fixing point

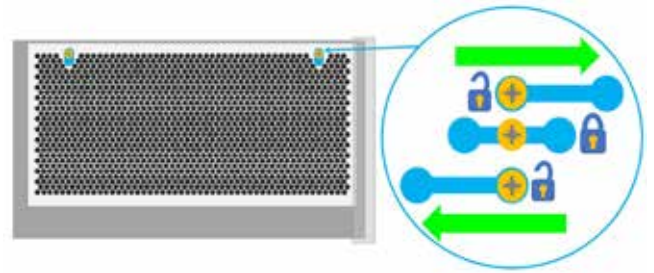

Figure 10 Dog bone screw fixing slot

4. On the GS units the lower cover can be removed by removing the two screws at the top of this cover and then pulled out of the tabs from the main case

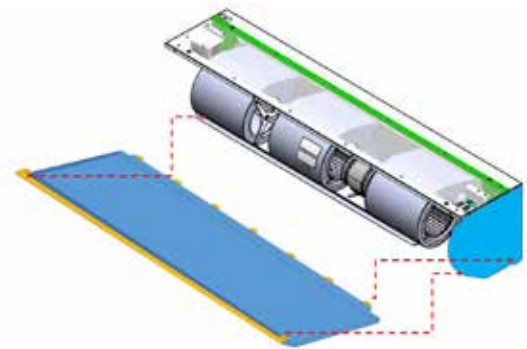

Figure 11 GS lower access panel

1. The GR has two captive screws in each panel, loosen these and hinge the panel down.
2. The panel can be removed completely by releasing the bolt hinges on either side of the panel (see figure 13).



Figure 12 GR cover fixing point

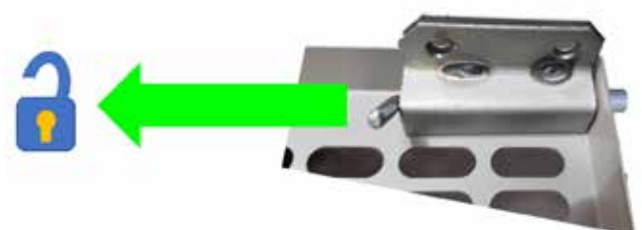

Figure 13 GR bolt hinge

Suspending on drop rods

1. The product is installed using 4 x M10 drop rods fitted into the fixing points in the top of casing.
2. The drop rods must completely pass through the fixing points in the case without being too long to cause damage to products inside the case.
3. Ensure that the secure mounting point in the ceiling is capable of supporting the weight of the unit.
4. Lift the unit (using lifting equipment) onto drop rods ceiling fixing point.

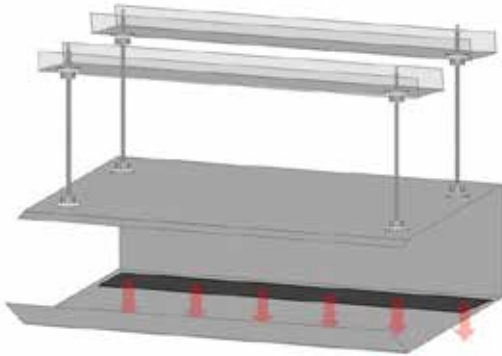

Figure 14 Suspending from drop rods

5. Level the unit and tighten the fixing points. Carryout a final check to ensure the unit remains level
6. Holes are provided in the casing for cable entry. Choose the appropriate hole to suit the installation. Note the terminal connection block is located to the right of the unit.
7. Install the cable into the case using a suitable cable gland for size of cable
8. Two RJ45 ports are located in the case to connect the program panel and any other air curtains to be controlled
9. Adjust outlet to required angle to give desired performance and tighten outlet grille.
10. Fit the display panel and commission the unit

Wall mounting bracket



Figure 15 Wall mounting bracket

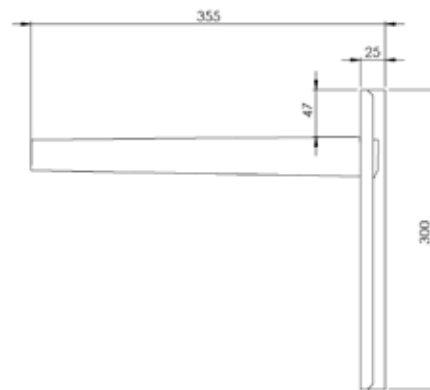

Figure 15.1 Side view

Figure 15.1 shows the overall dimensions of the wall bracket assembly.

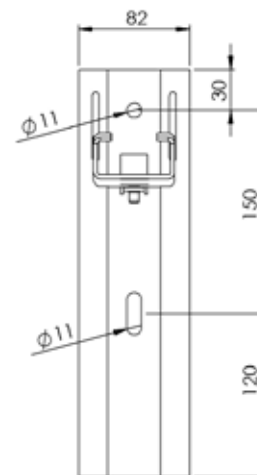

Figure 15.2 Front view

Figure 15.2 shows the dimensions of the bracket that is to be fixed to the wall, along with fixing positions. Please ensure that adequate fixings and wall structure are present to support the unit weight.

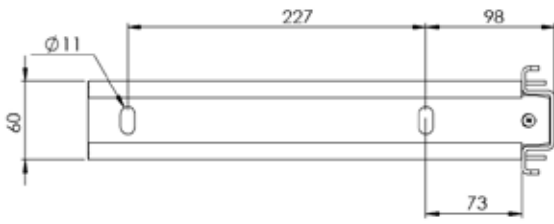

Figure 15.3 Mounting bracket top view

Figure 15.3 shows the dimensions of the bracket section that is to be fixed to the unit using 4 x M10 x 30mm 8.8 set screws, 4 x shake prove washers and 4 x flat washers. Use the four fixing points supplied in the casing

1. Using the details supplied with the bracket position the bracket against the wall at the desired mounting height and mark through the holes
2. Drill the wall then fix the brackets in position. Lift the chassis (using lifting gear if necessary) onto drop rods in the bracket
3. Ensure the unit is level and then tighten the fixing points with a final check to ensure the unit is level
4. Follow the instructions 6 to 10 of the drop rod mounting instructions grill.

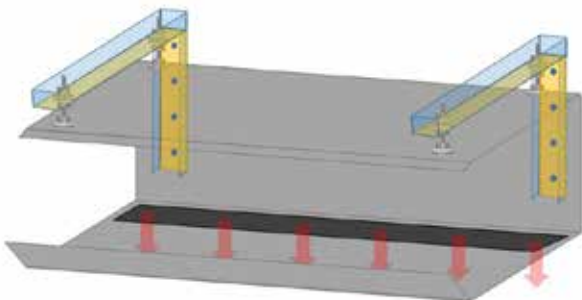

Figure 16 Mounting bracket option

Signal Pro display panel

The display panel can be installed using the standard double surface box supplied with the program panel or recessed using a suitable flush mounted double conduit box. see "Figure 5.2 Surface mounting back box dimensions" on page 9 for details



Figure 18 Display panel

The display panel can be connected up to a maximum of 16 air curtains in one network.

For mains wiring refer to the wiring diagram on page 17

The display panel is connected to the base unit in the air curtain via pre-wired RJ45 cable/plugs. These cables are available in 2, 10, 20, 30, 50 and 100m lengths. It is recommended that this control cable is run separately within its own trunking to avoid external interference.



Maximum cable run in any network must not exceed 100m in total including program panel cable.

Note: All air curtains connected within the network system will operate under the settings of the single display panel.

Any air curtain within the network can be connected with and respond to the following optional circuits:

- External switch (ie BMS enable) where required, to be volt free and wired in PARALLEL via normally open contacts to each terminal pair 'TIMER'. (Contacts closed to enable). Only air curtain(s) wired this way will respond to the enable signal.
- Door switches where required, to be volt free and wired to INDIVIDUAL base units via normally closed contacts to each terminal pair 'DOOR'. (Contacts open to enable door mode). Only air curtain(s) wired this way will respond to the door mode.
- An external sensor, where required, can be wired to INDIVIDUAL base units to each terminal pair 'EXT'. Only air curtain(s) wired this way will respond to the sensor setting.

Optional wiring

At the Installers terminal block, remove the required jumper(s) and then wire in any external connections that are required.

External switch (i.e. BMS enable) to be volt free and wired via normally open contacts to terminal pair 'TIMER'. (Contacts closed to enable). Remove factory fitted jumper J1.

- Door switch to be volt free and wired via normally closed contacts to terminal pair 'DOOR'. (Contacts open to enable door mode). Remove factory fitted jumper J2.
- An external sensor, where required, to be wired to INDIVIDUAL base units to each terminal pair 'EXT'. Only air curtain(s) wired this way will respond to the sensor setting.
- If the optional external temperature sensor is connected to the air curtain. If the external temperature is equal to the set temperature, all air curtains are turned off. The temperature must then drop to 3°C below the set temperature before the air curtains are turned back on.

- Protection. There are two high speed fuses on the electric model base unit to protect the switching thyristors for the heater. An external circuit breaker with the appropriate rating should be installed for the protection of the installation. See technical data for the correct MCB

Networking

The display panel is connected to the first air curtain via pre-wired RJ45 cable to the socket in the first air curtain housing. See figure 25 on page 18

Connect a second RJ45 cable in to the spare RJ45 socket of the first air curtain, and then take across to one of the RJ45 sockets in the second air curtain.

Further RJ45 cables can be used to connect more air curtains to the network, up to a maximum of 16 air curtains can be linked to one program panel.

The RJ45 cable is 10m as standard however it is available in 2m, 20m, 30m, 50m and 100m lengths.



Maximum length 100m. (Total length of cable used between program panel and last air curtain in network).

It is recommended that this control cable is run separately within its own trunking if possible, to avoid external interference.

Note: All air curtains connected within the network system can be controlled under the user settings of the single program panel.

Installer wiring - Electric heated models, single phase only

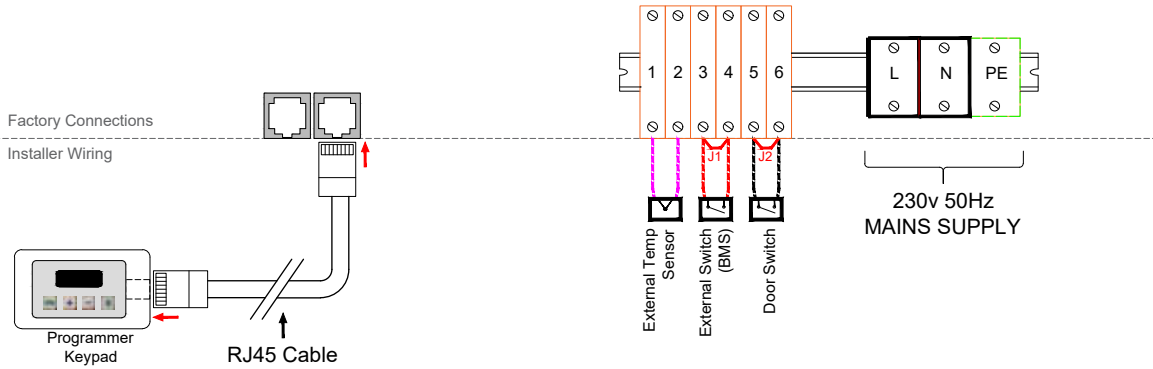

900733 Guardian Signal Pro Series 1-Phase Electric - Installer Connections

Figure 21 Wiring diagram electric heated

Terminal	Description	Cable
PE	Mains earth	10mm ²
N	Neutral	
L	Phase 1	

Table 7 Cable specification electric heated

Terminal	Description	Cable
3 & 4	Optional external switch	1.5mm ²
5 & 6	Optional door contact	
1 & 2	Optional external sensor	
PCB Fuses	Rating (A)	
F1	T1H (slow blow)	

Table 7.1 Cable specification electric heated continued

Protection

There are two high speed fuses on the base unit to protect the switching thyristors for the heater. An external circuit breaker with the appropriate rating should be installed for the protection of the installation

CONTROLLER

Introduction

The function of the display panel is to send commands to and receive status messages from up to 16 controls in a multi heater system.

The display panel has a microcontroller, a 16 character by 2 line display, 4 buttons and a communication interface. It also has a clock with battery back-up to provide time based control functionality. The display panel can be set to operate with different languages at the time of installation.

The display panel will work with all air curtains types: electric, legacy electric, LPHW/Ambient and legacy LPHW. Electric and legacy electric air curtains can operate in a mixed network. However due to differences in operation new LPHW and legacy LPHW air curtains cannot be mixed in a network but can be operated in separate networks.

Additionally the new electric air curtain controls are compatible with legacy 3 button display networks however, again due to differences in operation, the new LPHW/Ambient air curtain control will not work under control of a legacy 3 button display.



The display panel is powered by a battery mounted within the panel. The yellow tab under the battery must be removed to enable the battery. A warning will be provided at the display panel when the battery needs to be changed.



Networking

The display panel is connected to the first air curtain via pre-wired RJ45 cable to the socket in the first air curtain housing. See figure 25 on page 19. Connect a second RJ45 cable in to the spare RJ45 socket of the first air curtain, and then take across to one of the RJ45 sockets in the second air curtain.

Further RJ45 cables can be used to connect more air curtains to the network, up to a maximum of 16 air curtains can be linked to one display panel. The RJ45 cable is 10m as standard however it is available in 2m, 20m, 30m, 50m and 100m lengths.



Maximum length 100m. (Total length of cable used between display panel and last air curtain in network).

It is recommended that this control cable is run separately within its own trunking if possible, to avoid external interference.

Note: All air curtains connected within the network system can be controlled under the user settings of the single display panel.

Air curtain addressing

All air curtains work on an address to communicate with the display panel and are supplied with an default address of '0'.

Where multiple air curtains exist in a network they must be re-addressed using a unique address (0-9/A-F). This is achieved using the 4 way DIP switch [2] mounted on the control panel base unit PCB.



Figure 23 DIP switch position

The display panel will check all addresses on first power up and the result will be displayed. All addresses will be viewed in rotation. Note: If any address is altered after initial power up or an air curtain removed after initial installation, the display panel will also retain the original address although unable to respond. To remove an unwanted address, rescan the whole network in the manner detailed in Engineers settings on page 22.



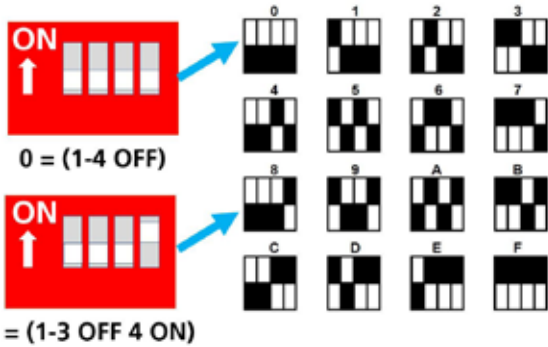

Figure 24 Air curtain address numbers

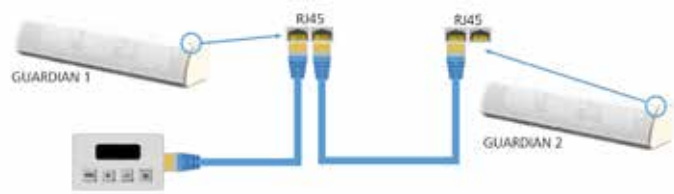

Figure 25 Wiring of 2 or more networked air curtains.

C

Keypad buttons

The buttons have the following functions:-



MENU enters the programming menu and advances item to program in order below.

OK starts programming of visible item, value flashes during programming.

PLUS and MINUS adjust the value.

OK saves the modified value or MENU stops programming with value reverting to old value.

If more than one air curtain is connected to the network then for some settings all controls can be set together or controls can be set individually. Only controls that are present on the system can be programmed, others are skipped over.

Air curtains are addressed as 0 to 15 by the display, corresponding to bit switch settings 0 to F on the air curtain control.

Keypad display



AC:0 - denotes air curtain address '0'

22° - denotes internal temperature 22°C

H:OFF - denotes Heat off status

DOOR CLOSED - denotes door closed status



Th - denotes Day on Thursday

13:08 - denotes 1:08pm (24 hr clock)

ON1 - 'ON' denotes this air curtain is active, '1' denotes Internal Timer

OS:23° - denotes Outside temperature 23°C

Operation

In normal operation the home screen displays the status of the display panel and each connected air curtain in sequence. Each screen is displayed for two seconds.

Display Status

Top line shows day and time.

If the panel is using internal timer then the program time status, "ON1", "OFF1" etc will also show.

Bottom line shows the outside temperature which is an average of all connected outside sensors.

If the panel has low battery then "LOW BATT" is also displayed.

If Overtime is active then the panel status instead shows overtime countdown in the top line.

Top line shows air curtain address, measured temperature (air outlet temperature for electric AC or flow temperature for LPHW AC), heating on "H1" or off "H0", and fan speed "F0" for off or "F1", "F2", "F3". Ambient AC shows "Ambient" in place of flow temperature and heat.

Bottom line shows operating mode: "ON MODE", "OFF MODE" or "AUTO". If the air curtain has an active input that will be shown in the bottom line as either "DOOR CLOSED" or "TIMER OFF".

If the air curtain is off due to outside temperature limit then that will be shown in the bottom line as "OS TEMP LIMIT".

If appropriate, interlock status "INTERLOCK DOOR", "INTERLOCK TIMER", "INTERLOCK FILTER" or "INTERLOCK STAT" will show in the bottom line.

If there is any error from the air curtain that will display in the bottom line. Errors are:

- "COMMS ERROR"
- "SENSOR ERROR"
- "OS SENSOR ERROR"
- "PCB TEMP ERROR"
- "BLOCKED FILTER"
- "STAT TEMP ERROR".

Examples:-



User operation

Press MENU button to enter User mode

Order of programming menu:

1. Set operating mode On/Off/Auto, All or Individually.



OK starts address flashing with ALL.



Use PLUS and MINUS to select all or single address then OK. Operating mode starts flashing.



Use PLUS and MINUS to select On, Off or Auto then OK to set. If address was ALL the sequence finishes and returns to MENU. If address was individual then next address is flashing. Use PLUS and MINUS to set address, then OK to modify mode or Menu to exit.

2. All Off mode.



A single press of OK quickly starts OFF operation for all air curtains, no heat and no fan, and then returns to default display.

3. All Auto mode.



A single press of OK quickly starts Auto timed operation for all air curtains and then returns to default display.

When in Auto mode during an on time period the air curtain controls to the individually set temperatures and fan speeds.

When in Auto mode during an off time period the air curtain has no heat and no fan.

4. All On mode.



A single press of OK quickly starts On operation for all air curtains and then returns to default display.

5. All Heat Off.



A single press of OK quickly starts Heat operation for all air curtains and then returns to default display.

6. Set door open temperature, all or individually.



OK starts address flashing with ALL. Use PLUS and MINUS to select all or single address then OK.

Temperature starts flashing. Use PLUS and MINUS to select temperature, range is fixed by low and high limits, then OK to set.

If address was all the sequence then finishes and returns to MENU.

If address was individual then next address is flashing. Use PLUS and MINUS to set address, OK to modify temperature or MENU to exit.



7. Set HEAT ON/OFF, all or individually



Use PLUS and MINUS to select all or single address then OK.

HEAT ON starts flashing. Use PLUS and MINUS to select On or Off then OK to set.

C If address was all then the sequence finishes and returns to menu.

If address was individual then next address is flashing. Use PLUS and MINUS to set address, then OK to modify mode or Menu to exit.

8. Set overtime.



OK starts overtime with HH:MM = 00:00



Use PLUS and MINUS to set overtime in 30 minute steps up to 12 hours then OK to start overtime.

Overtime causes air curtains to run as an on time period to the door open/door closed temperature and fan settings whilst running back to zero.

9. Set time and day.



OK starts Day flashing



Use PLUS and MINUS to adjust day (Mo to Su) then OK.

Hours starts flashing.



Use PLUS and MINUS to adjust hours (00 to 23) then OK.

Minutes starts flashing.



Use PLUS and MINUS to adjust minutes (00 to 59) then OK. After this OK the new Time and Day is stored.

If MENU is pressed at any time the original Time and Day is restored.

10. Set time program (not if BMS Timer).

Set time program is only displayed when the panel is set to internal time clock mode in engineers settings



OK starts Day flashing.



Use PLUS and MINUS to adjust the day (Mo to Su) which is to be programmed then OK.



ON 1 set time starts flashing. Use PLUS and MINUS to adjust ON 1 set time (00:00 to 23:59 or --:-- if on period is not needed) then OK.



OFF 1 set time starts flashing. Use PLUS and MINUS to adjust OFF 1 set time (ON 1 to 23:59) then OK.

Repeat for ON 2, OFF 2, ON 3, OFF 3. After OFF 3 OK display changes to Copy.



OK copies Monday times to Tuesday then offers "COPY TO We?" etc etc until Sunday. MENU continues programming of Tuesday differently to Monday etc.

11. Menu end.

When the user reaches the end of the menu they have a choice:



OK returns to home screen and MENU restarts the MENU at All On Mode.

Engineers instructions

Press '+' and MENU buttons to enter Engineers mode.

OK starts programming of visible item, value flashes during programming.

PLUS and MINUS adjust value.

OK saves modified value or MENU stops programming.

Order of programming menu:

1. Set door open fan speed, all or individually:



OK starts address flashing with ALL.



Use PLUS and MINUS to select all or single address then OK.

Fan speed starts flashing. Use PLUS and MINUS to select off, 1, 2, 3 then OK to set.

If address was all then the sequence finishes and returns to engineers menu.

If address was individual then next address is flashing. Use PLUS and MINUS to set address, OK to modify or Menu to exit.

2. Set door closed fan speed:



OK starts address flashing with ALL.



Use PLUS and MINUS to select all or single address then OK.

Fan speed starts flashing. Use PLUS and MINUS to select off, 1, 2, 3 then OK to set.

If address was all then the sequence finishes and returns to engineers menu.

If address was individual then next address is flashing. Use PLUS and MINUS to set address, OK to modify the fan speed or MENU to exit back to engineers menu.

3. Set door closed temperature:

Door closed temperature is only displayed if the system is detected as electric.



OK starts address flashing with ALL.



Use PLUS and MINUS to select all or single address then OK.

Door temperature starts flashing. Use PLUS and MINUS to select temperature, range is fixed by low and high limits, then OK to set.

If address was ALL then the sequence finishes and returns back to the engineers menu.

If address was individual then next address is flashing. Use PLUS and MINUS to set next address, OK to modify the temperature or MENU to exit back to engineers menu.

4. Set outside temperature operation:



OK starts outside temperature limit flashing.



Use PLUS and MINUS to select outside temperature limit, either Off or between 5 and 30, then OK. If outside temperature limit is set to OFF the sequence then finishes and returns to engineers menu.

If outside temperature limit is set to between 5 and 30 then an additional setting is displayed; elevate at zero temperature starts flashing.



Use PLUS and MINUS to select elevate at zero temperature, range is 0 to 9, then OK to set and return to engineers menu.



Elevate at zero temperature is a temperature boost at low outside temperatures and the scale is set using the boost at 0°C.

Note: All air curtains use the same outside temperature operation.

5. Set temperature limits:

Set temperature limits is displayed.



TEMP LIMITS?
OK or MENU=NEXT

OK starts low temperature limit flashing.



LOW LIMIT:10
+/-,OK or MENU

Use PLUS and MINUS to select low temperature limit between 5 and current high temperature limit, then OK.

High temperature limit starts flashing.



HIGH LIMIT:30
+/-,OK or MENU

Use PLUS and MINUS to select high temperature limit between current low temperature limit and 50, then OK to set and return to engineers menu.

Note: All air curtains use the same temperature limits.

6. Set int/ext time



INT/EXT TIMER?
OK or MENU=NEXT

OK starts INT/EXT Timer



INT PANEL TIMER
+/-,OK or MENU



EXT/INTS TIMER
+/-,OK or MENU

Use PLUS and MINUS to set INT/EXT timer then OK to return to engineers menu.

7. Set group interlocks.



SET INTERLOCKS?
OK or MENU=NEXT

OK starts lead address flashing.



LEAD ADDRESS:OFF
+/-,OK or MENU

Use PLUS and MINUS to select lead air curtain address either to OFF or to one of the air curtains discovered then OK.

If lead air curtain address is set to OFF then the sequence finishes and returns to the engineers menu; interlocks will not be enabled.

If lead air curtain address is set to an air curtain then this becomes the lead for interlock inputs and then timer input interlock is flashing.



TIMER INPUT:ON
+/-,OK or MENU

Use PLUS and MINUS to set timer input interlock off or on then OK.

Door input interlock is flashing.



DOOR INPUT:ON
+/-,OK or MENU

Use PLUS and MINUS to set door input interlock off or on then OK.

Over temperature stat input interlock is flashing.



STAT INPUT:OFF
+/-,OK or MENU

Use PLUS and MINUS to set over temperature stat input interlock off or on then OK to return to engineers menu.

Blocked filter input interlock is flashing.



FILTER INPUT:OFF
+/-,OK or MENU

Use PLUS and MINUS to set blocked filter input interlock off or on then OK and to return to engineers menu.

Note: The lead air curtain controls the interlocks for all other air curtains on the network.

Note: Not all interlocks are available on all air curtains. Any interlocks not present on an air curtain will be ignored. This is done so that future changes to inputs will not require updated panel operation.

8. Display hours run:



HOURS RUN?
OK or MENU=NEXT

OK Shows lowest numbered air curtain's hours run. ## below is the air curtain address.

Use PLUS and MINUS to view next air curtain or Menu to exit back to engineers menu.

9. Set language:

OK starts language flashing.

Use PLUS and MINUS to select language from available options then OK and back to engineers menu.

10. Reset connected air curtain address list:

OK starts no flashing.

Use PLUS and MINUS to select yes or no to scan connected air curtain addresses then OK.

If scan YES then the list of connected air curtains is cleared and the network scanned for connected air curtains and when finished returns to engineers menu.

If scan NO then the sequence returns to the engineers menu.

Note: This will cause the detected network type to be reset and rediscovered.

11. Reset panel to factory defaults:

OK starts no flashing.

Use PLUS and MINUS to select YES or NO to reset panel to factory defaults then OK.

If reset YES then the panel is reset to factory defaults, including clearing the connected air curtains list, before restarting.

If reset NO then just returns to engineers menu.

Note: This will cause the detected network type to be reset and rediscovered.

12. Engineer's menu end:

When the user reaches the end of the engineers menu they have a choice:

OK returns to home screen and MENU restarts engineers menu.



Diagnostics

PLUS and MINUS with MENU enters diagnostics menu.

Initial display:



```
DIAGNOSTIC
+, - or MENU=EXIT
```

C + and - change the air curtain displayed.

MENU exits diagnostics back to normal display.

All air curtain addresses are shown even if there is no AC installed.

Display if no air curtain is installed on this address:



```
AC1
NOT INSTALLED
```

Display if the air curtain on this address is not responding to the panel:



```
AC3
NOT RESPONDING
```

Display for active air curtains. Electric system:



```
AC3 H8 F8 12%
017 T18 P18 D
```

Where:

AC##, is address of AC with diagnostics being displayed.

H*, 1 = heat on, 0 = heat off from AC flag.

F*, 0 to 3 fan level from AC flag, 0 is off.

O***, outside temperature, range -25 to 99 or "--" if temperature range error or "" if no sensor.

T**, electric control temperature, 0 to 99 or "--" if temperature range error.

P**, electric PCB temperature, 0 to 99 or "--" if temperature range error.

S, Stat input (S = open, blank = closed).

F, Filter blocked input (F = open, blank = closed).

T, Timer input (T = closed, blank = open).

D, Door input (D = closed, blank = open).

Function narrative of the unit:

electric air outlet temperature when "outside limit" is set

When 'Outside Limit' is set for an electric control the installer can set the outside limit temperature and the elevate at zero temperature.

When the outside temperature is above the outside limit the fan will continue to run but the heat output will be off.

When the outside temperature is below 0°C the air outlet temperature will be the set temperature plus the elevate at zero temperature.

When the outside temperature is in between these two points the outlet air temperature are scaled between the two points as shown in the graph below.

In this example the outside limit temperature has been set to 22°C, the outlet air temperature (eg Door Open or Door Closed temperature) has been set to 25°C and the elevate at zero temperature has been set to 5°C.

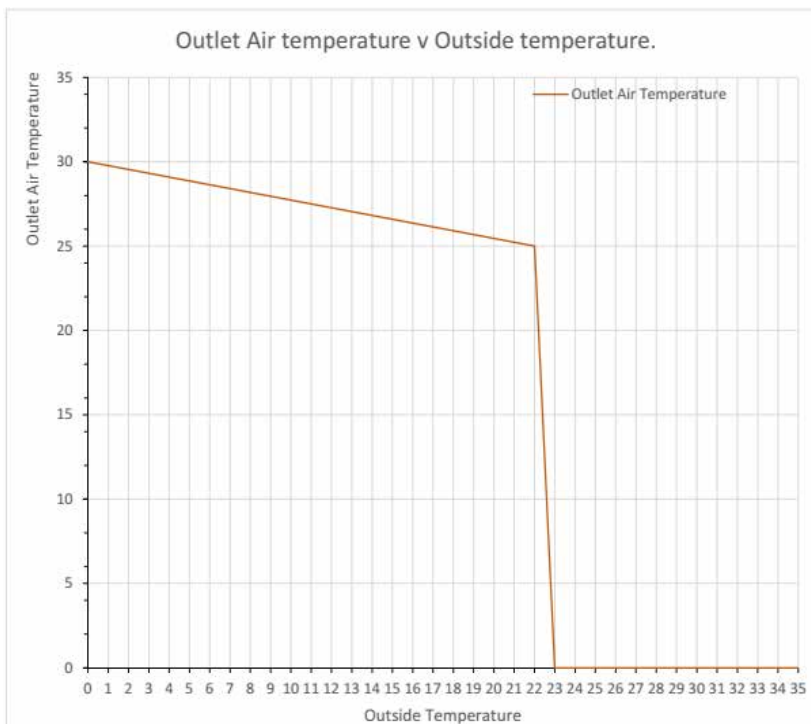

MODBUS Protocol

The modbus hardware is configured as follows:

- RS485 serial half-duplex interface
- 9600 baud
- 8 bits
- even parity / no parity (see below)
- 1 start bit
- 1 stop bit
- RTU mode

C This means the same software will run in a standard panel driven display and also in modbus mode, but in a modbus installation only 8 maximum controllers may be supported.

Modbus address – the unit will respond to it's own coded address as set by the bitswitches as follows: It will also respond to 'broadcast' mode 0.

Even parity settings (Bitswitch3 OFF)		No parity settings (Bitswitch3 ON)	
Modbus Address	Switch Setting	Modbus Address	Switch Setting
16	0	24	8
17	1	25	9
18	2	26	A
19	3	27	B
20	4	28	C
21	5	29	D
22	6	30	E
23	7	31	F

Modbus function codes supported

Codes	Descriptions	Range of arguments
01, 02	Read coils, read discrete inputs (equivalent)	Coils 1 to 24
03, 04	Read Holding registers, input registers (equivalent)	Registers 121 to 126
05	Write single coil	Coils 13 to 24
06	Write single register	Registers 125, 126

All other MODBUS function codes will generate exception code 01, function not recognised.

Function arguments — Registers			
0	Controller type	Read only	(undefined)
122	System control temperature	Read only	
123	Outside air temperature	Read only	
124	Power ratio	Read only	
125	Set point temperature	Read/write	
126	Set point temperature on door down	Read/write	(always to nearest 5°C)
127	Hours run	Read only	(16 bit result)

Function arguments — Coils

Arguments which are outside the ranges for registers and coils in the lists below will cause exception code 02 error address out of range

1	Fan1	Read only	Set if fan 1 actually running
2	Fan2	Read only	Set if fan 2 actually running
3	Fan3	Read only	Set if fan 3 actually running
4	Timer_link	Read only	Set if timer link open circuit
5	Phase rotation	Read only	Arbitrary indication of phase
6	Stat_link	Read only	Set if thermostat link open circuit
7	Door_link	Read only	Set if door link open circuit
8	Status_heat	Read only	Set if heating elements on
9	Status_temp	Read only	Set if system temperature measurement fail
10	Status_hs	Read only	Set if heatsink temperature measurement fail
11	Status_ext	Read only	Set if external temperature measurement fail
12	Ext_exists	Read only	Set if external thermistor not fitted
13	Set_fan1	Read/write	Switch fan 1
14	Set_fan 2	Read/write	Switch fan 2
15	Set_fan 2	Read/write	Switch fan 2
16	Heat	Read/write	Switch heat demand on/off A
17	Timer_link_mask	Read/write	Set to force timer link open circuit operation
18	0	Read/write	May indicate fault condition if read returns '1'
19	Stat_link_mask	Read/write	Set to force thermostat link open circuit operation
20	Door_link_mask	Read/write	Set to force door link open circuit operation
21	Set_doorfan 1	Read/write	Switch fan 1 when door link open circuit
22	Set_doorfan 2	Read/write	Switch fan 2 when door link open circuit
23	Set_doorfan 3	Read/write	Switch fan 3 when door link open circuit
24	0		System reset (*)

(*) A read or write to this coil causes the addressed controller to execute a restart as if being powered up.

There is no response and the unit will not respond to further commands until approximately 1 second has elapsed.

Arguments which are outside the ranges for registers and coils in the lists above will cause exception code 02 error - address out of range.



Maintenance and servicing



Always ensure that the main external electricity supply is switched off and lock the switch (if fitted) before commencing any maintenance on this heater



To obtain the best results from the heater, it is essential to avoid the accumulation of dust and dirt within the unit on the air inlet and discharge grilles. For this reason, regular cleaning is necessary, paying particular attention to the removal of dirt build up on the fan assembly.

MS

Cleaning of the fan is best carried out with a soft brush and vacuum cleaner

The product should be serviced annually, by a competent person.

- 1. GS units.** Loosen the two screws securing the inlet cover and slide towards the end cover, now loosen the two screws in the next panel and slide towards the first panel which will then allow this panel to be released and lifted out of the dog bone slot This panel can then be lifted out of the tabs at the bottom to fully release. see figure 9 on page 12
- 2. GR units** loosen the screws securing the inlet grille and hinge down, the grille can be removed by releasing the spring loaded bolt to either side. See figure 12 and 13 on page 12



Figure 26 GR Inlet cover

3. With a soft brush clean away any dust from the motor and elements.

4. Check the security of all the components
5. Check for any signs of deterioration and replace components as necessary
6. Inspect the wiring for damage, chaffing of the outer case, damage cut or crushed and security in the terminals
7. Check that the fuses are rated correctly.
8. Clean the honeycomb outlet

Inlet foam filter replacement GS

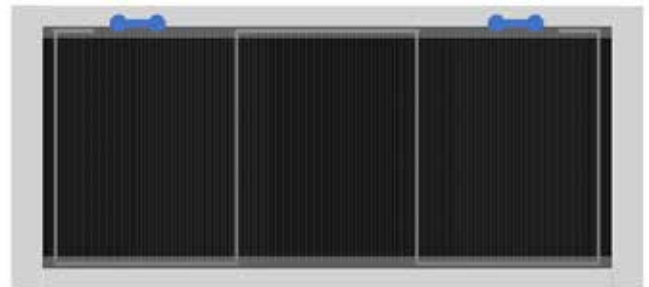

Figure 27 GS inlet foam retaining clip 1

1. Remove and replace the foam inlet filter, by unhooking the leg of the clip and passing it through the dog bone hole in the frame, then release the remaining parts of the clip to allow the foam filter to be removed and replaced. Carefully refit the clip and ensure the foam is not creased and secure.



Figure 27.1 GS removing the inlet foam retaining clip

Inlet foam filter replacement GR

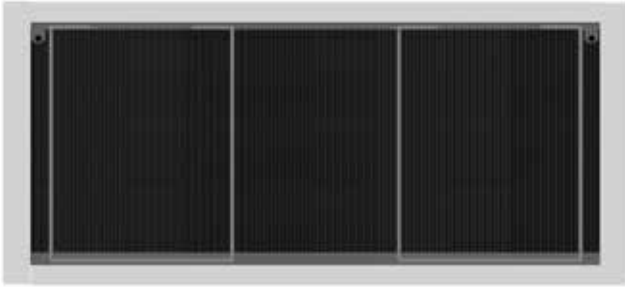

Figure 28 GR inlet foam retaining clip 1

1. To remove the filter element of the GR units, select the clip from either end of the panel, push the outside leg of the retaining clip towards the centre of the filter/inlet grille which will release the clip out of the inlet grille frame, work along the clip releasing until the clip is fully out of the frame.
2. The filter element can now be removed and replaced with a new element reverse the procedure to refit and re-secure

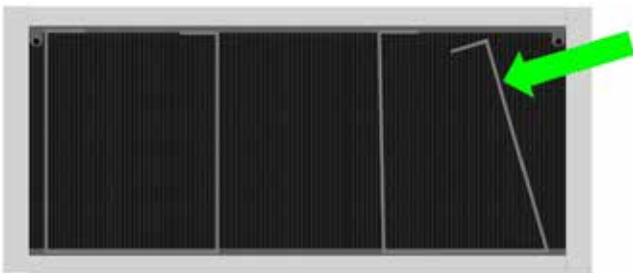

Figure 28.1 GR removing the inlet foam retaining clip

Honeycomb outlet replacement

To remove the honeycomb outlet, first remove the complete carrier. The carrier is secured at one end by a bolt and stud to the other end. Remove the end panel to access this fixing bolt and then release the carrier from the stud side, on the 2m models the centre support can be moved to one side to allow the stud side to be released

On the GS units peel back the tabs which retain the honeycomb outlet, remove the honeycomb media from the carrier and replace. Then fit the new honeycomb media into the carrier and push the tabs back over the honeycomb to secure

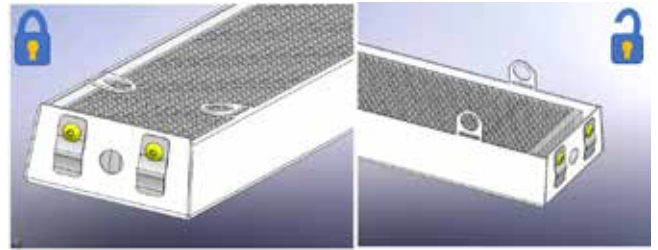

Figure 29 GS honeycomb retaining

On the GR units the tabs are part of a retaining plate, peel back the tabs which retain the honeycomb outlet remove the media from the carrier and replace. Then fit the new honeycomb media into the carrier and push the tabs back over the honeycomb to secure

MS

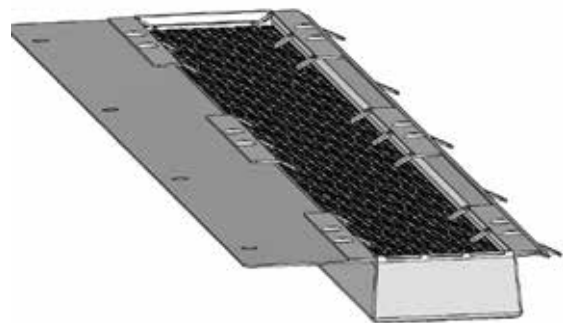

Figure 29.1 GR honeycomb retaining

Note the position of the temperature sensor from the right of the unit and ensure it does not get damaged, the cables will need to be disconnected from the control panel terminals TEMP, refit in the position given in figures 30 and table 9. (below)

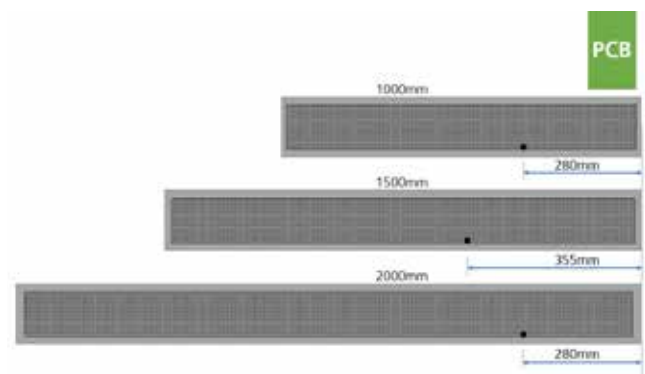

Figure 30 Temperature sensor position

Model length	Unit	Position from right
1 metre	mm	280
1.5 metre	mm	355
2 metre	mm	280

Table 9 Temperature sensor position

Fault finding.

General

All Air Curtains are fitted with fuse protection and motor thermal protection.

Other faults in relation to the element, motor and wiring should be identified using conventional fault-finding techniques. In the event that electrical components are replaced, please ensure that electrical safety checks in accordance with the regulations in force in the country of use are undertaken.

FF

For the service engineer, please note that there is a thermal cut-out incorporated in the air curtain which needs to be manually reset. The cut-out is located near to the control panel, note 2m has two, with the second located near the centre of the fan deck.

Re-setting the thermal cut-out may help to identify the nature of the fault however we do not recommend re-setting without a thorough investigation into why the cut-out operated.



Figure 31 Thermal cut-out

Display panel.

Any fault will be described on the display panel until the fault has been cleared.
temperature fault.

There are five basic checks to perform should a fault appear on the program panel display. These are as follows:

- Continuity: Use a multimeter to check continuity between each end of the cable cores.
- Short circuit: Use a multimeter to check that there are no short circuits between any of the cable cores.
- Plugs: Check that the plugs are firmly seated in the circuit board sockets in both the program panel and on the circuit board
- Addressing: (Network versions only). If two or more air curtains are networked, check that each base unit has a unique address as described in air curtain addressing on page 18.
- Network cables: Ensure that the total run of all cables in the network does not exceed 100m including the cable to the program panel.

Signal Pro fault descriptions and remedies

Description	Symptom	Possible cause	Remedy
Communications failure	No control on unit	Bad data cable connection Damaged cable	Check data cables and plugs Replace damaged cable
Air sensor failed	Fan operating, no heat	Air sensor cable disconnected Air sensor broken	Check cable Replace air sensor
Air sensor temp too high	Fan operating, no heat	High ambient air temperature Incorrect motor or fan deck rotation Motor failure	Check ventilation Check rotation of the fan deck Check motor, replace if necessary
Ext. temp sensor failure	Unit runs but no external temperature control	External temperature sensor faulty	Repair faulty wiring Replace faulty sensor
Overheat stat open circuit	Fan operating, no heat	Overheat stat open circuit	Replace overheat thermostat

Table 10 Fault codes



Spare parts.

Note Any spare part components that are not approved by the manufacturer could invalidate the approval of the appliance and validity of the warranty.

General

Right hand & left hand is when viewed from inside of the building, looking at the unit into the door opening.



Figure 32 Handing of the unit

SP

Component	1000	1500	2000
Generic components			
Fan deck assembly	1026174	1026175	1026174 x 2
Signal Pro display panel	108221-RJ45-2		
Resistor	n/a	1037491	n/a
Honeycomb core	1026068	1026078	1026068 x 2
Inlet cover assembly GS	1026849		
Inlet cover assembly GR	1026662	1026163	1026829
Inlet cover filter only GS	1026664		
Filter securing clip GS	1026910		
Inlet cover filter only GR	1026665	1026835	1026665 x 2
Filter securing clip GR	1026962		
End cap GS left hand	1026505		
End cap GS right hand	1026506		
Control fuse T1H (1A 5mm x 20mm)	2140		
Control panel (base unit)	1038710		

Table 11 Spare parts

Parts replacement.



Warning
Ensure electrical power is isolated from the product.

For access follow steps as stated in Installation Section on page 12

1. GS units, remove all of the front covers, remove the cover plate to access the control panel, installers terminal block, transformer and fan deck (motor and fans).
2. GR units, completely remove the inlet panel

Control panel



Make a note of the wiring at the control panel. Make a note of the dip switch settings

Make a note of the installer terminal block wiring

1. Disconnect the wires from the control panel terminals including the earth connections which are bolted to the chassis.
2. Disconnect the installer terminal block assembly by removing the two screws securing the block bracket to the control panel mounting plate
3. Remove the control panel, this is secured by two screws in the control panel mounting bracket situated to the top of the bracket furthest away from the honey comb outlet grille.
4. With the control panel out of the unit disconnect the blue wire from the temperature sensor.
5. Replace the control board and reverse the steps remembering to reconnect the temperature sensor wire which goes through the hole in the PCB

Reverse the steps to install the new control panel

Set the dip switch for the location and follow the networking address settings. For more information refer to the section on page 18.

Heating element

1. Follow steps to remove the covers
2. Remove the fixing bolts holding the honey comb outlet grill assembly and remove this.
3. Make a note of the wiring at the control panel for the heating element and the temperature sensor
4. Disconnect the wires at the heating element to the control panel
5. Remove the fixing bolts in the fan deck mounting plate which secures the heating element.
6. Remove the heating element
7. Make a note of the wiring to the heating element including all the jumper positions
8. Remove the wires and fit to the new element pass them through ready for connection to the control panel
9. Refit the heating element and reverse the steps to install the new heating element
10. Ensure the temperature sensor is refitted in the correct position and wired into the TEMP terminal of the control panel.

Fan deck

1. Follow the steps to remove the covers and the control panel, complete with its mounting bracket as one of the fan deck securing nuts are under the control panel bracket.
2. With the control panel and bracket out of the unit disconnect the wire from the motor

SP

G

3. Remove the wires to the thermal cut out sensor, (two sensors on the 2 metre units) and remove the thermal cut out.
4. Remove the four securing nuts, shake proof washer and flat washer that secure the fan deck.
5. Lift out the fan deck
6. Replace the deck and reverse the steps to install the new fan deck

Notes

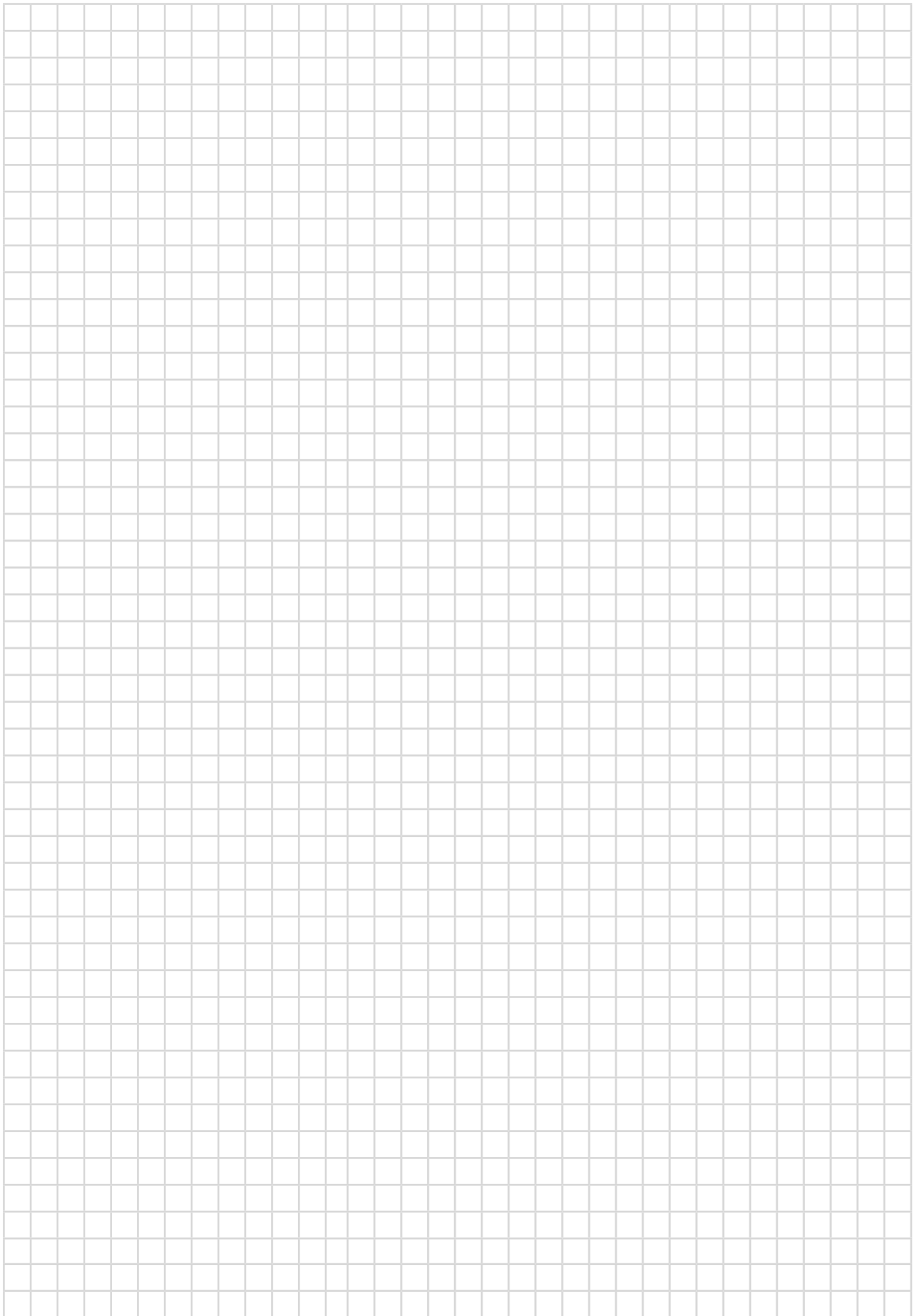



NORTEK GLOBAL HVAC (UK) LTD

Fens Pool Avenue
Brierley Hill
West Midlands DY5 1QA
United Kingdom
Tel +44 (0)1384 489700
Fax +44 (0)1384 489707
reznorsales@nortek.com
www.reznor.eu

Nortek Global HVAC is a registered trademark of the Nortek Global HVAC Limited. Because of the continuous product innovation, Nortek Global HVAC reserves the right to change product specification without due notice.