



VISION COMPACT

GAS FIRED RADIANT
TUBE HEATERS

Operation, maintenance
and servicing manual
VC12 & VC20

Index

- 1 Vision Compact gas fired radiant tube heaters
- 2 Gas connection
- 3 Standards
- 4 Electrical connection
- 5 Fan assembly
- 6 Vision Compact herringbone gas radiant heaters
- 7 Health & safety
- 8 Installation - suggested methods of heater suspension
- 9 Installation of Vision Compact heaters
- 10 Flue connection
- 11 Fresh air ducted inlet (all models)
- 12 Commissioning for individually flued and unflued heaters
- 13 Routine service
- 14 Herringbone adjustment
- 15 Replacement of components
- 16 Trouble shooting checklist
- 17 Spare Parts
- 18 Method for calculating equivalent flue resistance - Appendix 1
- 19 User instructions for Ambi-Rad Vision Compact of heaters
- 20 Important information



1 Vision Compact gas fired radiant tube heaters

This heater is for use on:-

Natural gas G20, 20 mbar, Propane G31, 37 mbar / 50 mbar.

2 Gas connection

The gas connection on the Vision Compact heater is R1/2 (1/2 in. BSP internal thread).

Natural gas

Max supply pressure 25 mbar

Min supply pressure 17 mbar

Propane

Max supply pressure 57.5 mbar

Min supply pressure 30 mbar

Correct burner gas pressure is indicated in the table below.

Before installation, check that the local distribution conditions, nature of gas and pressure and adjustment of the appliance are compatible.

Injector gas pressure

Model	Natural Gas G20	Propane G31
VC12	8.8 mbar	27.0 mbar
VC20	8.9 mbar	26.6 mbar

Technical data

Model	VC12	VC20
Nominal heat input gross		
Natural Gas (G20) kW	11.4	19.5
Propane (G31) kW	11.4	18.5
Injector size		
Natural Gas (G20) mm	3.0	3.8
Propane (G31) mm	1.9	2.3
Number of injectors	1	
Gas flow rate		
Natural Gas (G20)	1.1	1.85
Propane Gas (G31)	0.43	0.69
Gas supply	Connection R 1/2 1/2 BSP external thread	
Gas pressure		
Natural Gas (G20)	max. 25.0 mbar - min 17.5 mbar	
Propane (G31)	max. 57.5 mbar - min 30 mbar	
Electrical supply	230 Volts 1 phase 50 Hz	
Current rating	0.55 amps max. (inductive)	
External fuse rating	3 amps	
Ignition	Electronic programme start-up with spark ignition	
Noise level dBA @ 3m 'free field'	48	
Dimensions mm	1703L x 1254W x 201D	
Flue diameter OD	102mm single wall or 127mm twin wall	
Ducted air diameter OD	102mm	
Total installed weight kg	91	
Minimum mounting height m	4.3	5.2
Electrical motor details	V220 ac 50Hz Class F	
Fan rating	0.5A	

3 Standards

Ambi-Rad heaters must be installed in accordance with the relevant provisions of the Gas Safety (Installations and Use) Regulations 1998. Due account should also be taken of any obligations arising from the Health and Safety at Works etc. Act 1974. In addition the installation must be carried out in accordance with the current IEE 1992 (BS 7671), BS 6896:1991 (Industrial & Commercial) and any other relevant British Standards and Codes of Practice.

A gas meter is connected to the service pipe by the local gas region or a qualified local gas region contractor. An existing meter should be checked preferably by the Gas Region or a qualified local Gas Region Contractors to ensure that the meter is adequate to deal with the rate of gas supply required. Installation pipes should be fitted in accordance with BS 6891:1998, such that the minimum pressure at least, as stated in the table below will be achieved and any other British Standards and Codes of Practice. Pipes of smaller size than

the heater inlet gas connection should not be used. The complete installation must be tested for soundness as described in the previous standard.

The gas supply must not be in the position where it is subject to overheating.

The gas union service cock **MUST** be fitted in the gas supply close to the heater, but not onto the burner itself.

It is essential to provide some flexibility in the final gas connection by use of a tested and certified metallic hose to BS 6501 Part 1:1991 (minimum acceptable quality Type 'B' Class 1). When stainless steel flexible hoses are used the hose should be connected in a 180 (bend without any strain or torsion). (See figure 1).

Note: Take care when making a gas connection to the heater not to apply excessive turning force to the internal controls.

Figure 1 Correct installation of flexible gas connection

Corrugated Flexible Metallic Hose Assemblies to BS 6501 Part 1 1991 Class 1 Type C
Construction 1 m long – Ambi-Rad Part No. 6500-2

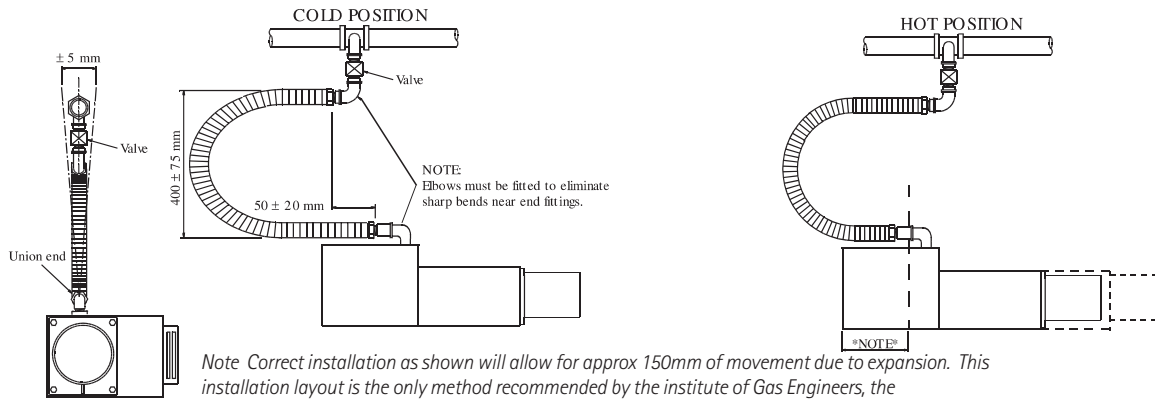

Note Correct installation as shown will allow for approx 150mm of movement due to expansion. This installation layout is the only method recommended by the institute of Gas Engineers, the manufacturer and Ambi-Rad Ltd. These instructions must be carried out in accordance with the relevant provisions of the gas safety (installation and use) regulations 1991 (as amended) and the manufacturers recommendations.

Corrugated Flexible Metallic Hose Assemblies to BS 6501 Part 1 1991 Class 1 Type C
Construction 600 m long – Ambi-Rad Part No. 6500

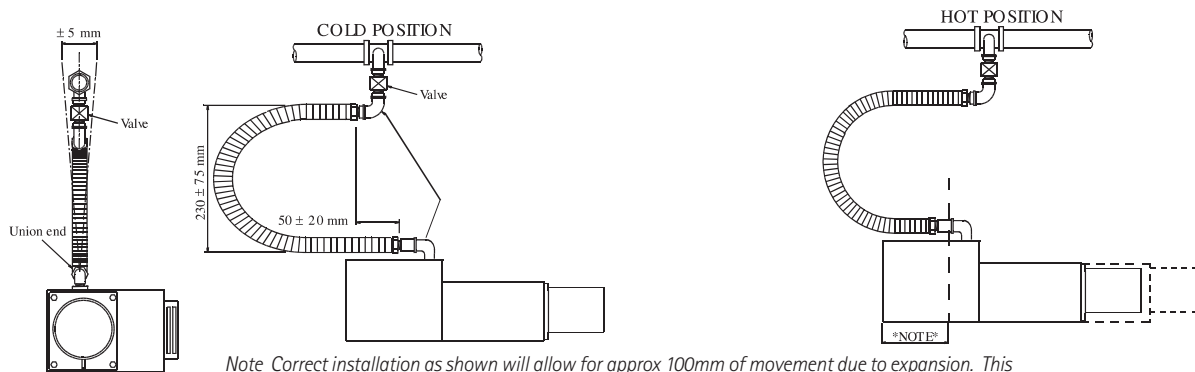

Note Correct installation as shown will allow for approx 100mm of movement due to expansion. This installation layout is the only method recommended by the institute of Gas Engineers, the manufacturer and Ambi-Rad Ltd. These instructions must be carried out in accordance with the relevant provisions of the gas safety (installation and use) regulations 1991 (as amended) and the manufacturers recommendations.

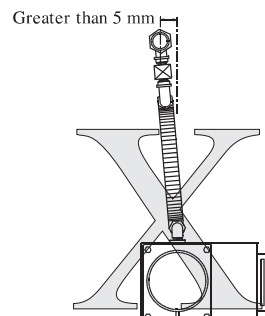
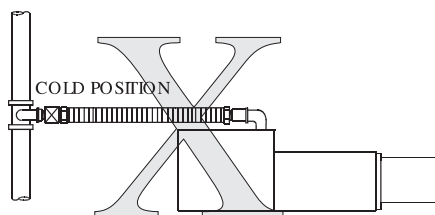
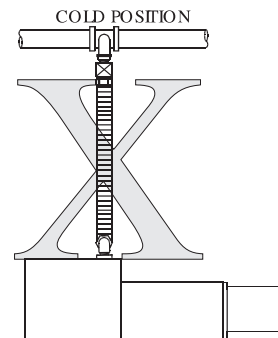
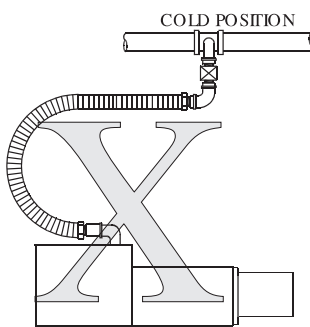

4 Electrical connection



This appliance must be earthed.

Supply 230V 50Hz single phase.

Current rating 0.55 amp max (inductive).

Fuse: external 3 amp.

All electrical work should be carried out to IEE standards by a competent electrician. The electrical connection to the heater is made by means of a three pin plug-in power connector. Live, neutral and earth connections should be made via a flexible supply cable to the power connector and routed clear of the heater or tubes. The flexible supply cables should be of 0.5mm² complying with BS 6500:1990.



Wiring

The wires in the mains lead are coloured in accordance with the following code:

Green & Yellow Earth

Blue Neutral

Brown Live

Instructions for connecting mains lead to plug:

Connect green and yellow to plug terminal marked E. Connect blue wire to terminal marked N. Connect brown wire to terminal marked L.

It is recommended the electrical circuit controlling the heater or group of heaters incorporates thermostats, a time switch and if required manual control switches and a frost thermostat.

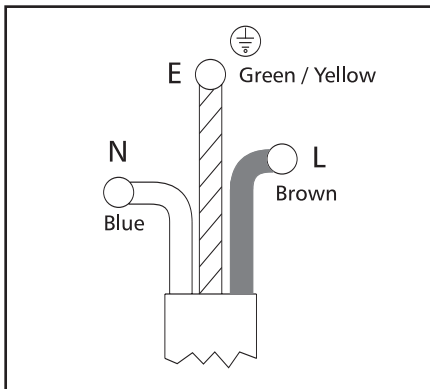

Circuits and controls

All such controls and switchgear must be rated to handle the total inductive load of the circuit they control. Load per Ambi-Rad heater is 0.55 amp. For large installations, the use of relays and contactors should be considered. The method of connection to the electrical supply must facilitate complete isolation and should be made via fused double pole isolator having a contact separation of at least 3mm in all poles and supplying the appliance only.

Alternatively, connection may be made via a fused three pin plug and un-switched shuttered socket, both complying with the requirements of BS 1361:1971 (1986).

Ensure that a copy of the lighting instructions plate is affixed adjacent to the electricity supply switch. Should this switch serve more than one heater it is only necessary to affix one copy per service.

Thermostats and other controls

For details on the use and siting of thermostats (if used) refer to Ambi-Rad leaflets Doc Ref GB/CON/002/0902.

Figure 2 Typical external wiring

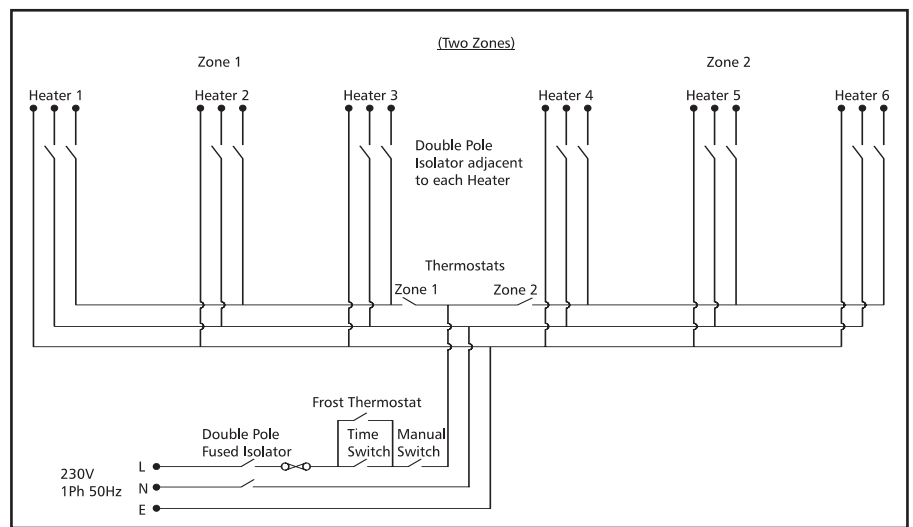

Note For more comprehensive control arrangements see black bulb and control panel leaflets

Figure 3 Internal wiring diagram

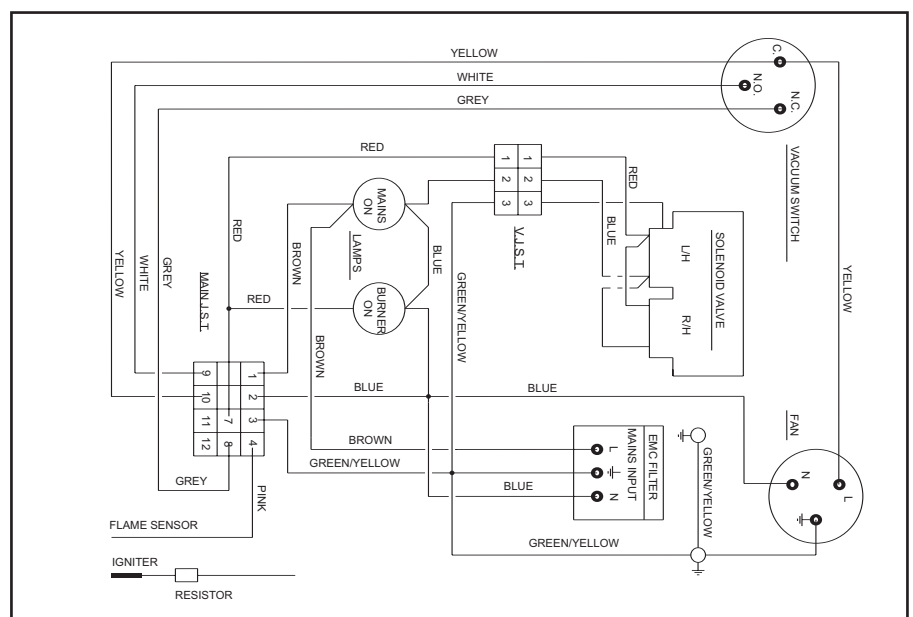

5 Fan assembly

Note For both horizontal and inclined mounting the fan assembly must be perfectly vertical with the fan outlet facing upwards.

For unflued heaters a fan baffle must be attached to the fan outlet.

6 Vision Compact herringbone gas radiant tube heaters

For herringbone heaters refer to the relevant information leaflet (GB/HB/134/0402).

A herringbone system allows several Vision Compact heaters to be operated by one combustion fan. This has the benefit of only one building penetration being required when fluing the products of combustion.



7 Health & safety

Ambi-Rad Limited cannot be responsible for ensuring that all site safety procedures are adhered to during assembly and installation. Sole liability rests with the installer.

8 Installation – suggested methods of heater suspension

Attachment to the heater support lugs should be made by either a 'speed link', D shackle, nut bolt and large washers, or in the case of drop rods, a closed formed hook. The hanging attachments to overhead steelwork etc. must be purpose made to good sound engineering practice or of a proprietary type fixing. They must be adequately fixed and designed to carry the whole weight of the heater.

In the event of suitable roof steelwork not being available, additional steelwork should be fitted to enable vertical hangers to be used for suspending the heaters.

If there are any doubts as to the strength or suitability of roof steelwork to which heaters are to be suspended, please refer to consultant / architect / owner of the building.

The recommended minimum and preferred mounting heights, along with the recommended clearance to combustibles for the Vision Compact range of heaters is shown in the table below.

Clearances 1

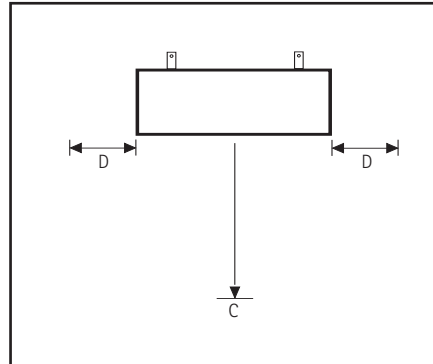

Clearances 2

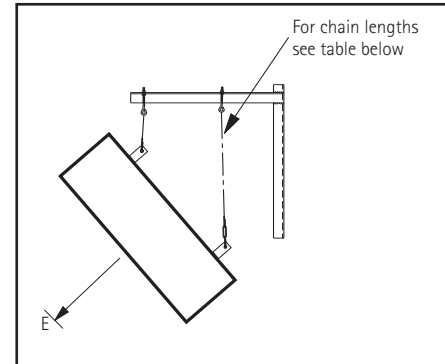

Clearances 3

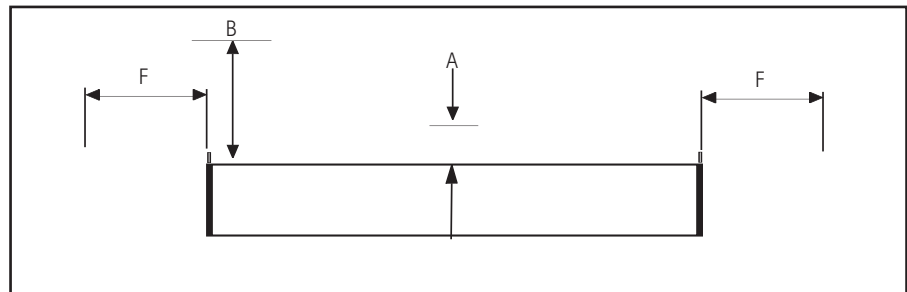

Model	Required angle	Additional chain length (mm)
All models	30°	575
	45°	730

Note Minimum recommended mounting heights

Model	Horizontal (m)	Inclined 30° (m)	Inclined 45° (m)
VC20	5.2	4.7	4.7
VC12	4.3	3.9	3.9

Clearance distances

Model	CB20	CB12
A. Above reflector (fan unflued)	570	570
B. Above burner/fan assembly unflued	570	570
C & E Beneath tubes	1600	1370
D. To the sides	1050	670
B. Above reflector and fan outlet flued	400	400
F. From ends	640	640

All dimensions are in millimetres

9 Installation of Vision Compact heater

Health & safety

A qualified installer is required to install the appliance in accordance with the rules in force, and should the need ever arise to convert the appliance for use with other

Installation

There is no on site assembly required for the VISION COMPACT of heater.

Attach an appropriate hanging attachment to each of the four hanging brackets.

The heater can be installed with the packaging in place to protect the casing from damage during installation.

Raise the heater into the air and affix to the chain previously located of 4mm (minimum) gauge galvanised welded link construction. Alternatively, 10mm diameter mild steel drop rods can be used.

Wall mounting brackets must support the heater at an angle of inclination between 30° and 45°, and are available from the manufacturer. The angle can be varied by adjusting the drop rods or chain on each bracket. The bracket positions are critical and when suspended they should have the same orientation i.e. all the same angle.

Note When installing the heater at an angle the combustion fan outlet should be positioned so that it remains vertical.

It is recommended that sufficient clearance from any fixed structure (e.g. a wall) is given above the burner and behind the burner / fan compartment to allow sufficient room for the service of the heater. (See section 8 on clearances).

Note As a part of the heaters annual service all dust deposits on the top of the reflector should be removed before the start of each heating season.

Figure 4 Mounting of Vision Compact heater

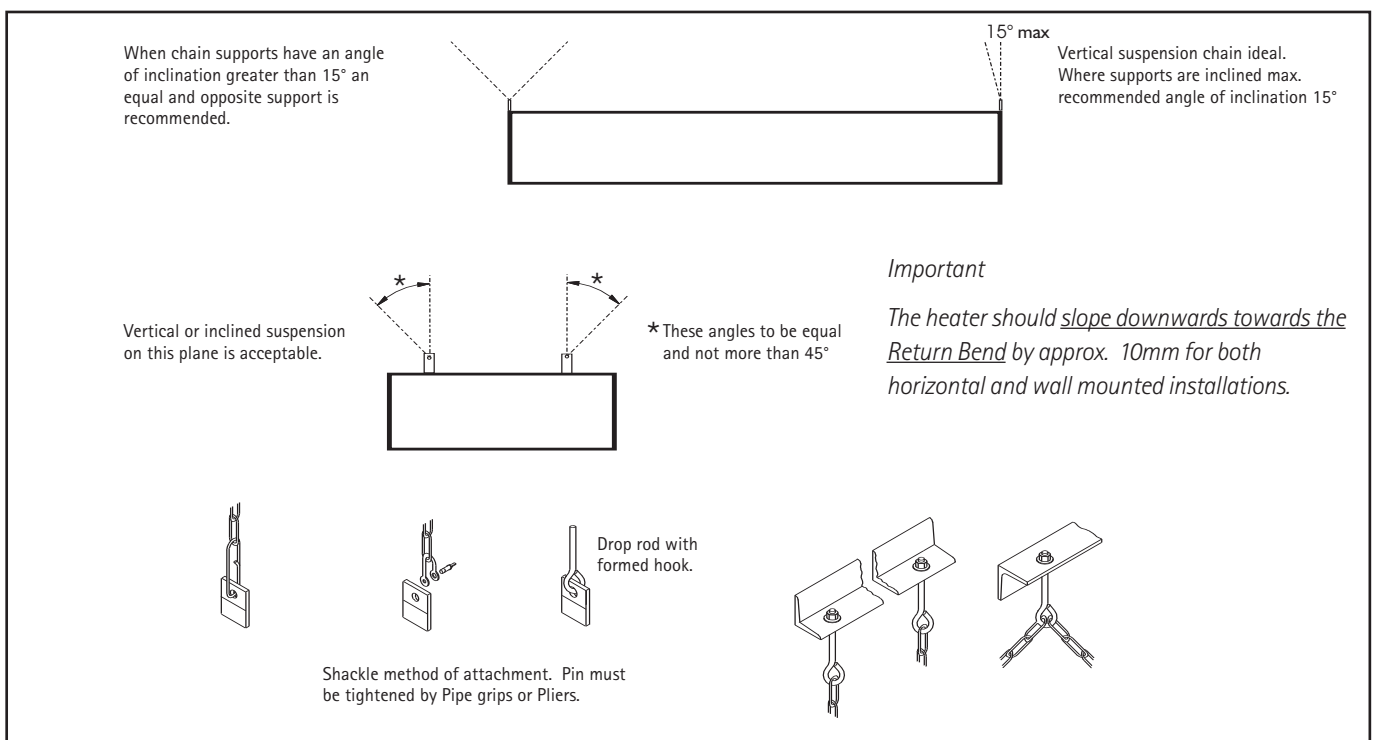

10 Flue connection

Flue technical details

Model	VC20		VC12	
	G20	G31	G20	G31
Gas type				
Mass flow rate of flue gases (kg/s)	0.0113	0.0105	0.0077	0.0077
Flue gas temperature (°C) @ fan outlet	234	228	163	164
Flue pressure (Pa) Positive	184	184	144	144

The Vision Compact heater may be installed with or without a flue to atmosphere providing the air supply and building ventilation requirements as stated in BS 6896: 1991 are complied with and providing due consideration is given to the possibilities of condensation forming on cold surfaces when used as an unflued heater.

Where a ball guard is fitted to the heater a downdraught diverter (Supplied as an optional extra by Ambi-Rad) must be fitted to the induced fan outlet by means of the screws and clamp plates provided.

Unflued installation

Permanent ventilation required is as follows:

Natural ventilation

(To be fitted at high and low level with minimum distance between of 3m).

Low level, when air change rate is less than 33m³/h/kW of total rated input, either:
1.4cm² for each 1m³/h/kW below 33m³/h/kW or 46cm²/kW of total rated input.

High level, above areas where personnel are working is as above.

Mechanical ventilation

Minimum proven air flow is 33m³/h/kW of total rated heated input.

If the heater is installed without a flue, ensure that combustion gases do not impinge on combustible materials. The maximum permitted temperature for such materials is 50°C. EN416.

The heater must have a baffle plate (supplied) fitted to the fan outlet if it is to be unflued.

Flued installations

Individually flued

A downdraught diverter (Supplied as an optional extra by Ambi-Rad) must be fitted to the induced fan outlet by means of the screws and clamp plates provided.

The fan flued adaptors are designed to accept 5" twin wall (recommended) or 5" single wall, subject to necessary precautions to prevent condensation forming within the flue.

On individually flued heaters, the flue must be terminated vertically and correctly sealed.

The maximum length of flue is 7m.

Draught diverter spillage checks

With the appliance in operation carry out a flow visualisation check using a smoke producing device e.g smoker match, puffer or joss stick. The device shall produce an even trace so that the flow can be observed and the venting of the combustion products assessed.

Check the flue performance at the draught diverter. All of the smoke, apart from the odd wisp which may be discounted, should be drawn into the flue and removed to the outside air.

If spillage occurs leave the appliance operating for a further 10 minutes and re-check. If there is still spillage switch off the appliance and rectify the fault.

For further details see BS 5440-1:2000.

Permanent ventilation is required as follows:

Natural ventilation

(Preferably at low level) Up to and including 60kW: 4.5cm²/kW.

Over 60kW: 270cm² + 2.25cm²/kW in excess of 60kW total rated input.

Forced ventilation

Minimum proven air flow is 2.35m³/h/kW of total rated input. For detailed information please refer to BS: 6896:1991, Installation of Gas fired Overhead Radiant Heaters for Industrial and Commercial heating (2nd and 3rd) family gases.

For calculation method for flue sizing see Appendix.

Herringbone flue system

Where a number of individual heaters are to be flued together via a herringbone system, each heater must be fitted with a herringbone damper assembly. The damper assembly enables the correct vacuum to be set for the heater, and is sized to accept 100mm diameter manifold pipe (all supplied by Ambi-Rad at the design stage. Please refer to the Herringbone Information Manual (GB/HB/134/1103 if designing and installing herringbone flue systems.

All flue pipes whether individual or herringbone system should be adequately supported at regular intervals from the building structure and terminates externally with a certified terminal.

11 Fresh air ducted inlet (all models)

When the Vision Compact heater is to be installed in locations where there is airborne dust or where there is a polluted atmosphere e.g. chlorinated vapours, process dust etc., a ducted fresh air supply must be provided to the burner. Where a fresh air ducted inlet is to be fitted to the burner assembly the aluminised steel air intake grill must be removed from the burner casing and the D/A fitting attached over the burner orifice plate.

These models incorporate a 100mm (4in) fresh air duct connection (Pt. No. M201601-SUB). A fresh air duct of minimum 100mm (4in) diameter should be connected to the D/A duct. A flexible joining piece should be used, available from the manufacturer (Pt. No. 7531), fixed with hose clips to facilitate disconnection when servicing the burner.

The maximum length of fresh air inlet duct is 7 m of 100mm (4in) diameter duct, the maximum number of bends is two. The fresh air inlet duct can be installed either vertically or horizontally. A position should be selected for the inlet of the fresh air duct so that it will receive dust free clean air. A cowl of the British Gas tested and certified type, such as the GCI or GLC terminal, should be fitted at the inlet of the duct. If the duct inlet is located on a roof the underside of the inlet cowl must be at least 600mm (2ft) above roof level and at least 250mm (10in) higher than any projection on the roof within a 2m radius of the cowl.

12 Commissioning for individually flued and unflued heaters

Figure 5

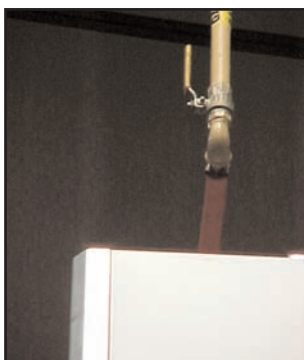

Inspect installation and ensure that it has been carried out in accordance with these instructions. Ensure that electrical and gas supplies are isolated. The gas supply should be purged and tested for soundness in accordance with the BS6891:1988, BGIM/16, IGE Report 1M/2 and any other British Standard and Codes of Practice. Open isolating valve.

Figure 6

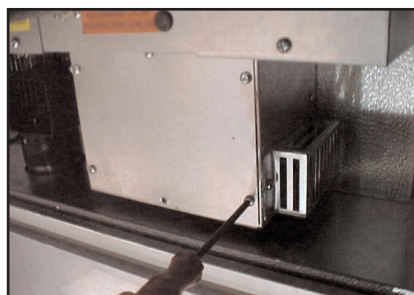

Remove the combustion chamber cover plate by unscrewing 6 fixing screws. Take care not to damage the sealing gasket.

Open the control housing cover by unscrewing the securing screws. Ensure all internal components are securely fixed and all connections securely made.

Switch on the electrical supply to the heater and observe the correct start up sequence as follows:

The mains lamp (red) will illuminate. The ID fan will start to run and the vacuum switch checking relay (inside flame electronic sequence control box) will pull in. Safe start checks are carried out automatically and a purge period of approximately 9 seconds will commence.

At the end of the purge period the ignition sequence will commence. The spark ignition will be energised producing a spark at the ignition electrode. The gas shut off valve

will at the same time be energised. If ignition is successful the flame is detected by the flame sensing probe and the ignition spark will be switched off. The 'burner on' (amber) lamp indicates that the gas safety control valves are energised.

If the ignition is unsuccessful the gas safety control valve is closed and the spark ignition de-energised after approximately 5 - 7 seconds.

After an unsuccessful ignition attempt the electronic sequence controller will 'lock out'. The 'power lamp' (red) only will remain illuminated and the fan will continue to run. To reset this 'lock out' condition, switch the power supply to the heater, wait 5 seconds then restore it. If repeated lock out occurs investigate cause.

In the event of an electrical fault after installation of the appliance preliminary electrical systems checks should be carried out (re earth continuity polarity and resistance to earth).

To shut down the heater, switch off the power supply to the heater. Automatic control of the heater or a series of heaters may be achieved by incorporating thermostats, time switches, frost thermostats, manual over-ride switches etc, in the electrical supply to the heater(s). It is essential to allow a delay of 15 seconds after switching off a heater before attempting to restart.

If at any time after completion of the start up sequences, loss of flame should occur, the electronic sequence controller will attempt to re-ignite. If this is unsuccessful lock out will occur.

Set burner gas pressure as follows:

Isolate gas supply. Unplug mains input connector to heater.

Figure 7



Unscrew the fixing screw in the housing lid and remove.

Figure 8

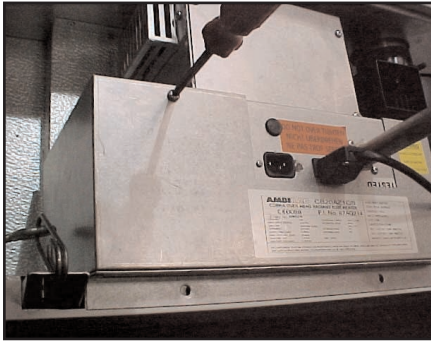

Remove pressure test point screw nearest the burner head and connect a 'U' tube manometer to the pressure test nipple located on the body of the gas valves. Remove the slotted cover from the pressure test regulator revealing the adjustable screw. Replace mains input connector and start the heater. Using a suitable screwdriver adjust the pressure regulator. Switch off the heater by pulling out the mains input connector. Disconnect 'U' tube manometer and refit screw in pressure test nipple.

If heater is flued check that there is adequate up draught at the down draught diverter e.g. by means of a smoking taper when heater is running. Check the operation of the flame safe guard equipment as follows. With the heater running normally, switch off the gas supply at the appliance isolating valve.

Check the operation of the vacuum proving switch as follows. With the heater running.

Observe that the 'burner on' lamp extinguishes within one second. After a purge period of approximately 9 seconds the heater should attempt to re-light and if the gas isolating valve has been left off, lock out should occur indicated by power light only being illuminated and fan running.

Check the operation of the vacuum proving switch as follows. With the heater running normally pull out the three pin fan connection plug, thus causing the fan slow down and stop. Within 3 seconds the burner should shut off.

Observe for at least 20 seconds that there is not attempt to re-ignite, then replace the three pin plug and observe that the heater proceeds to ignite in the normal way.

Close the safety control housing lid which is secured with the fixing screws.

Hand the 'User Instructions' to the user and explain how to operate the heater.

Leave the 'Installation and Servicing Instructions' at the users meter or preferably with the service / maintenance engineer / manager for use on future service calls.

Note It will be noted that heaters have a tendency for the U bend to glow. This is normal and quite acceptable.

13 Routine service

Frequency of servicing

The manufacturer recommends that to ensure continued efficient and safe operation of the Vision Compact it is recommended that the heater is serviced regularly by a competent person e.g every year in normal working conditions but in exceptional dusty or polluted conditions more frequent servicing may be required. The manufacturer offers a maintenance service. Details are available on request.

Tools required for servicing

The tools required to carry out any servicing of the Vision Compact range of heaters are as follows 4mm allen key; electrical screwdriver; 13mm spanner; 10mm spanner; 8mm spanner; cross head screwdriver; adjustable spanner; pipe wrench; soft bristle brush; and a soft cloth.

Recommissioning after service

After servicing of the heater has been completed it will be necessary to recommission the heater as outlined in the relevant section of the instructions.

Figure 9

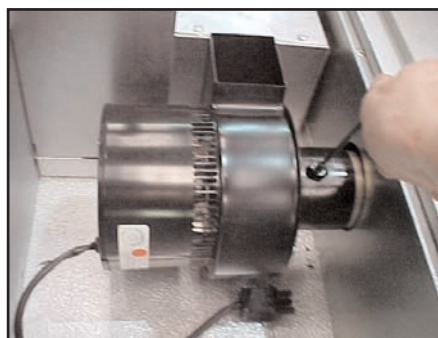

ID fan

Remove ID fan by unplugging the electrical connection from the burner / control assembly and loosening the fan securing pinch screw. If a flue is fitted, this must be disconnected. The fan will now slip off the emitter tube. Inspect the main fan impeller and remove any dust by brushing with a

soft brush. Similarly remove any dust from the finger guard covering the secondary (cooling) impeller and the mesh aperture in the motor cover. Ensure that the impeller turns freely and that there is no excessive play in the bearings. Do not replace fan until emitter tube inspection has been completed.

Figure 10

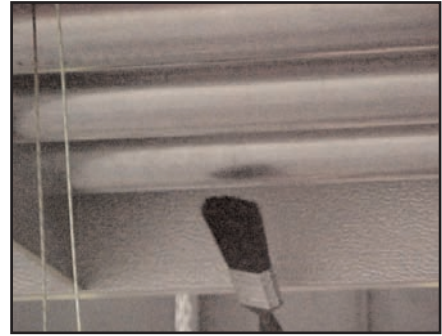

Emitter tube inspection

Brush away any dust on the exterior of the emitter tubes.

Access to the firing and return leg, tubes can be achieved by removing the outer panel at the burner end.

Remove the burner assembly and ID fan. Through the two access holes in the inner panel view down the tubes and if carbon deposits are evident clean out with a suitable rod.

Although not considered necessary on routine service, if heavy carbon deposits are present, it maybe necessary to clean down all the tubes. To do this, remove the reflectors tube clamps and burner assembly. Take the tube assembly out of the product and by removal of each leg and turbulator (where fitted) clean out the tubes and re-fit.

Access to the firing and return leg, tubes can be achieved by removing the outer panel at the burner end.

Inspect the emitter tubes internally. If there is any appreciable build up of dust or deposits the tubes should be cleaned internally. Remove the burner / control assembly as directed.

Reflector

It is recommended that the top of the reflector is cleared of any dust annually and or before the start of each heating season.

The condition of the reflector should be noted and the users attention drawn to any cleaning necessary. The reflector can be

simply withdrawn for cleaning by removing the M6 bolts securing it and lifting it off the heater. The reflector can be cleaned with a soft cloth and detergent in water. A mild non abrasive metal polish may be used in cases of extreme discolouration. Dirty reflectors will increase the heat radiation upwards into the roof space by 3-4%.

Sweeping of flue

As a part of the annual service of type B appliances the flue should be periodically swept in accordance with the regulations of the country that the appliance is installed.

For servicing of injector, electrode assembly, refer to Section 14.

14 Herringbone adjustment

Figure 11

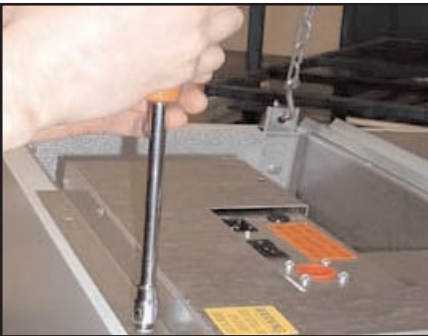

Remove the 2 M6 bolts and 2 M5 screws securing the rear burner cover.

Figure 12

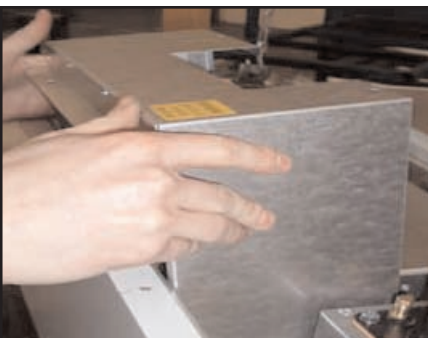

Remove the cover from the burner box.

Figure 13



Locate pressure tee piece.

Figure 14

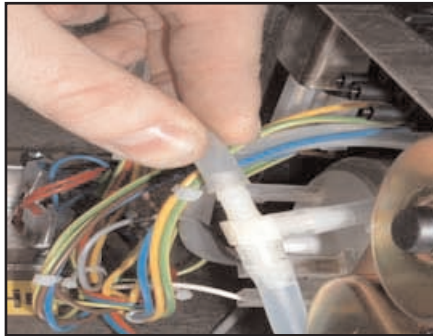

Attach u-tube manometer.

Figure 15



Loosen M8 grub screw on damper assembly and slide damper blade out fully for a VC20 and half way for a VC12

Commissioning

Refer to section 5 and follow the procedure for commissioning the installation using the relevant herringbone pressures shown in figure 23.

Heater Type	Damper Setting when hot (mbar)
VC12N	0.6
VC12P	0.6
VC20N	1.0
VC20P	1.0

15 Replacement and servicing of components in the burner assembly

Figure 11 Vision Compact burner assembly

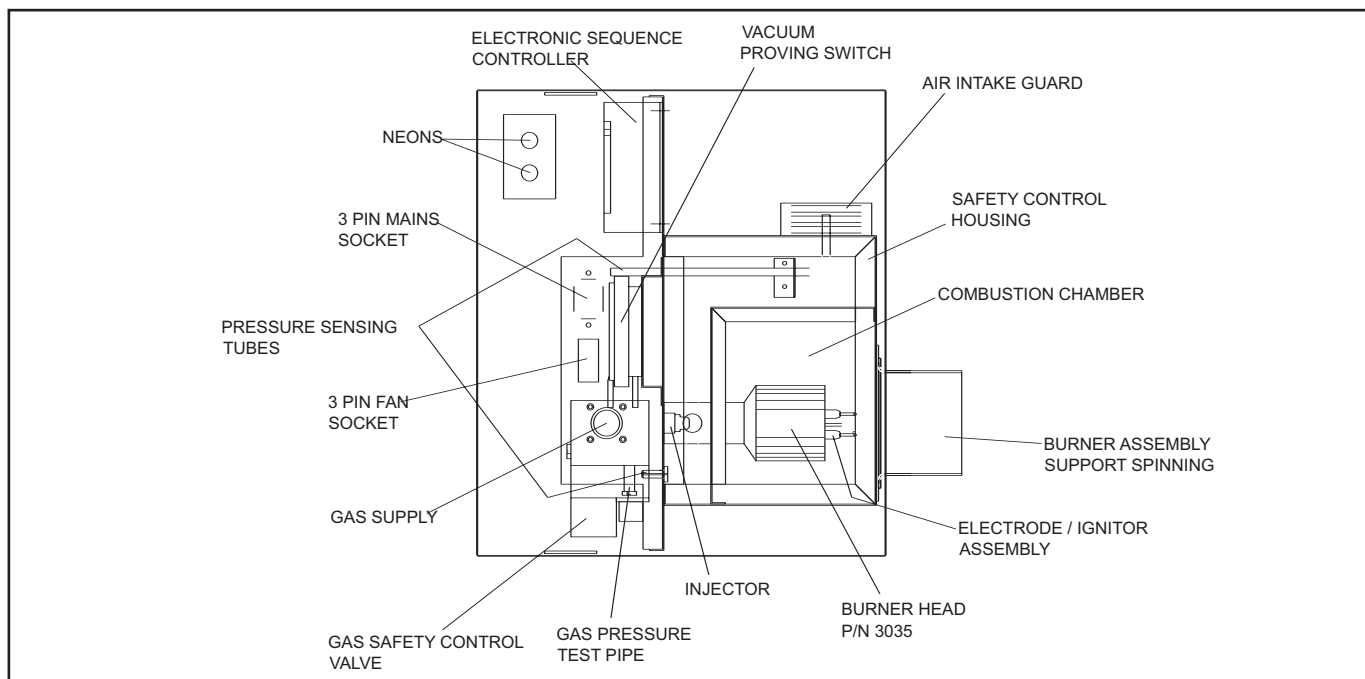

Health and Safety

Isolate gas and electrical supplies before carrying out any repair work. Always test for gas soundness with a suitable leak detection fluid.

Replacement parts

Any spare part components that are not approved by Ambi-Rad could invalidate the approval of the appliance and operation of the warranty.

It is recommended that the burner assembly is removed from the product to facilitate replacement of the following components:

- Burner head
- Injector
- Gas valve
- Electrode assembly
- Vacuum switch
- Electronic sequence controller

Figure 16

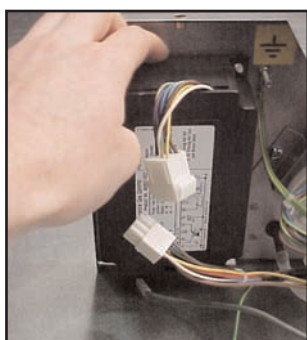

To remove the burner assembly proceed as follows

Figure 17

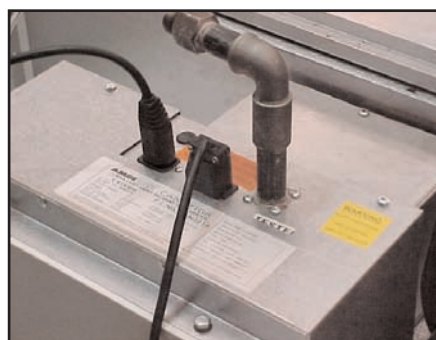

Withdraw the mains and fan male connectors/leads from the female connectors on the burner assembly. Isolate the gas supply and disconnect the gas feed pipe at the gas valve.

Figure 18

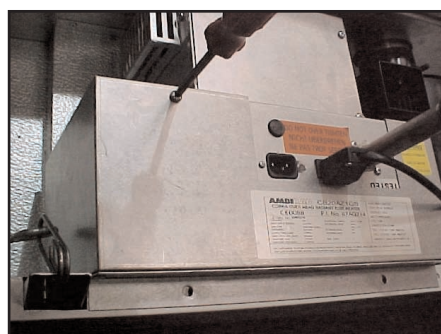

Remove the fixing screws securing the controls cover to the burner assembly and the side of the product. Remove the controls cover.

Figure 19

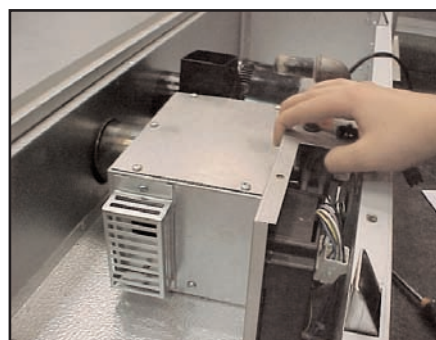

Slide the burner assembly back towards the side of the product until the burner spigot disengages from the firing tube and the end of the spigot is clear of the inner face of the controls divider plate. Lift the burner assembly from the product.

With the burner assembly removed from the product it is now possible to replace components as follows:

Burner head, Injector and Electrode assembly

Figure 20

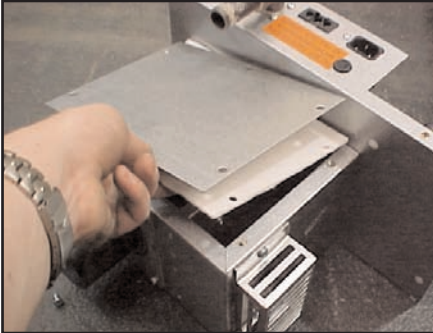

Remove the screws securing the combustion chamber cover. Lift off the lid and gasket checking the gasket for signs of splitting, and replace on re-fit as required.

Figure 21

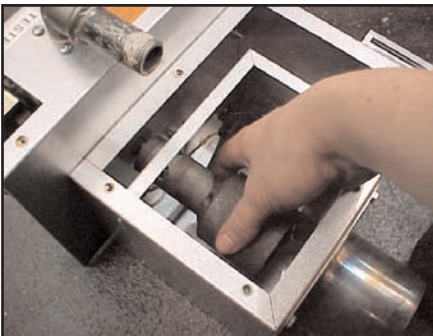

Using a screwdriver through the holes in the burner head, slacken then unscrew the burner head.

Figure 22



Slacken with a spanner, then unscrew the injector from its carrier. If servicing the injector, blow through orifice, never drill or broach out or use wire to clean. Replace if blocked.

Replace burner head and injector if necessary and re-fit components in reverse order of removal.

Electrode assembly

Figure 23

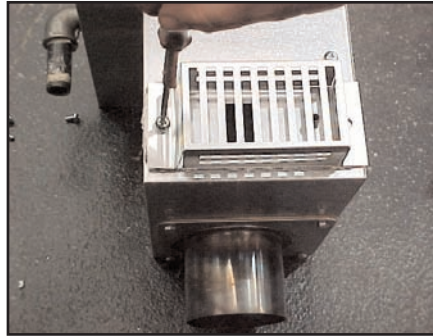

Remove the air grille or ducted air attachment from the side of the burner assembly.

Figure 24



Remove the screws securing the electrode assembly to the side of the burner assembly.

Examine the electrode assembly and if in not good condition replace as necessary by removing the screws as indicated and disconnection of leads from wiring harness.

On service or replacement of the electrode assembly check the spark electrode gap is 3.5mm = or -0.5mm.

Gas valve

Follow instructions for replacement of burner head and injector then proceed as follows:

Disconnect connectors on gas valve from wiring harness and remove silicon tube.

Figure 25

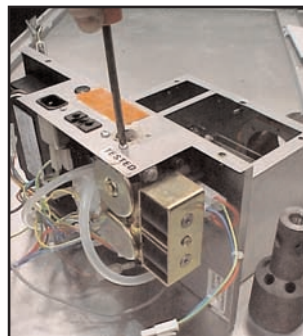

Remove the four screws securing the gas valve to the burner assembly. The gas valve can now be replaced.

After re-fitting in reverse order of removal, and prior to fitting the controls cover, ensure all joints are gas tight, and set burner pressure to that indicated on the data badge.

Vacuum switch

Figure 26

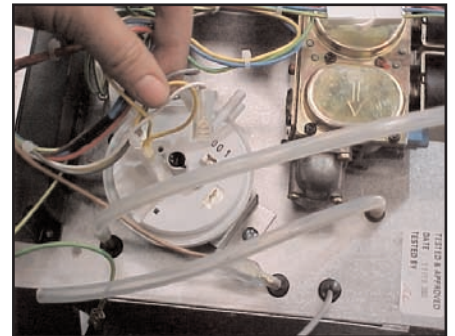

Disconnect the two silicon rubber tubes and the electrical connectors.

Figure 27

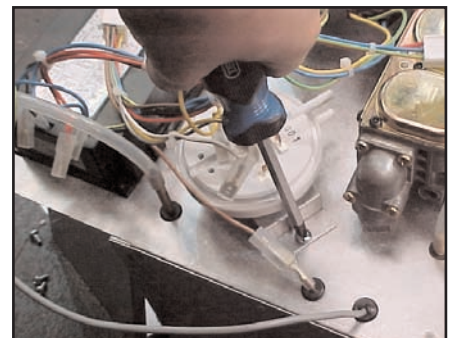

Remove the vacuum switch bracket screws the unscrew pressure from the bracket.

Re-fitting in reverse order of removal, then ensure connections are made as indicated in the diagram below.

Electronic sequence controller

Figure 28

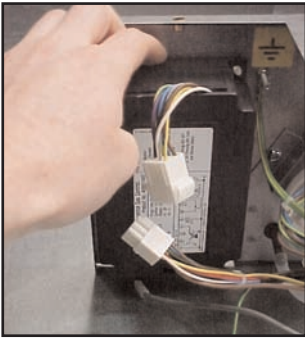

Disconnect the electrical connector from the controller to the wiring harness and the ignition high tension lead.

Remove the plastic push clips and replace the controller.

Re-fit in reverse order of removal ensuring electrical connections are made.

Figure 29 S.I.T vacuum proving switch

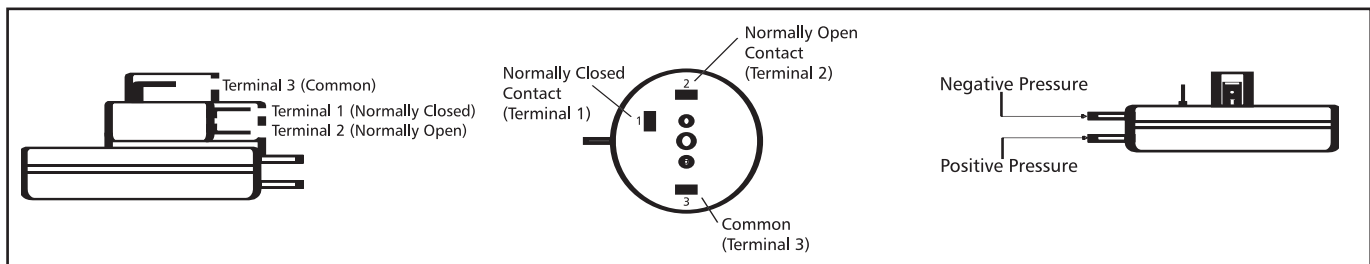

16 Trouble shooting checklist

Symptoms	Possible causes	Remedy
Burner will not start Red 'mains on' does not illuminate.	External controls, thermostats, time switch etc. not calling for heat.	Adjust controls.
	Fuse blown.	Check for short circuit in wiring or individual electrical components.
Red light illuminates.	Fan's connector plug not fully engaged.	Engage securely.
	Loose electrical connection.	Check all connections.
	Fan seized or faulty motor.	Replace fan, recommission heater, checking gas pressure settings.
	Sequence controller relay failing to pull in and/or hold in.	Check vacuum switch is satisfactory, replace sequence controller.
	Vacuum switch not returning to normal (switch off) position.	Replace vacuum switch.
HB Herringbone system only.	Fan tripped out on overload.	Check overload setting: single phase 3 phase 0.8 amp. Reset button on in control panel. Check for build up of condensate in fan casing.
Fan starts but burner does not attempt ignition.	Insufficient vacuum generated by fan.	Clean fan blades with soft bristle.
	Blocked emitter tube.	Clean emitter tube internally.
	Combustion chamber cover permitting air leakage.	Examine condition of sealing gasket, tighten down lid securely.
	Vacuum impulse line between combustion chamber and vacuum switch insecure or defective.	Fix securely in place.
	Vacuum switch 'pulls in' but electronic sequence controller does not proceed to programme ignition sequence.	Replace burner sequence controller unit but first check that the cause of failure is not a short on output circuit, by measuring resistance between pins 2 and 7 of burner control unit plug. A reading of 10,000 ohms indicates short circuit on gas valve burner indicator light or associated wiring.
HB Herringbone system only.	Leaks in joint separation in manifold system.	Reseal or reconnect.
Burner proceeds to ignition stage (normally indicated by audible spark valve energised and 'burner on' light illuminated) but burner does not light.	No spark.	Check electrode for cracks – replace if necessary. Check high tension connections are secure. Check spark gap is 3.5 ± 0.5 mm. If no high tension output from electronic controller, replace controller.
	Gas safety valve faulty or defective.	Replace solenoid operator section of gas valve.
	Insufficient gas pressure.	Set burner pressure to that indicated on data badge (see commissioning).
Burner lights but shuts down after a few seconds.	Inadequate flame signal. This can be verified by connecting a sensitive micrometer in series with the violet wire which passes through the combustion chamber bulkhead. The correct reading should be $6\mu A \pm 1\mu A$.	Replace electrode. Check connections to electrodes and terminal 4 of electric sequence controller plug. Replace the electronic sequence controller.
	Flame unstable.	Check cleanliness of burner and set burner pressure as indicated on data badge.
	Inadequate gas supply. Observe burner gas pressure with all heaters operating.	If gas pressure drops below that indicated on the data badge, examine gas supply pipework for excessive pressure loss.
	Insufficient vacuum at combustion chamber causing vacuum switch to cut off.	Clean fan blades with soft bristle brush. Inspect tube internally and clean if necessary (see servicing instructions).
Heater shuts down after operating for a period of time.	Refer to above.	If problem persists, replace vacuum switch.

17 Spare parts

Description	Part Number	VC12 Natural Gas (G20) or Propane (G31) only	
Igniter probes	3149-1	Fan orifice plate assembly	FSER12USA30
Burner head	3035	Pressure switch (SIT or EAC)	2190
Combustion chamber gasket	200553	VC12 Natural Gas (G20) only	
Support spinning gasket	M101391	3.0mm injector	4578
Combustion fan	2501	Burner orifice plate	3161-2MF
Pactrol control box	2015	Burner support spinning	200521-SUB
Gas valve	2052	VC12 Propane (G31) only	
Red neon	2180	1.9mm injector	4579
Amber neon	2175	Burner orifice plate	3161-2MF
Wiring harness	900055	Burner support spinning	200521-SUB
Gas valve harness	E300002		
HT lead	900064		
3 pin mains socket	2135-5		
3 pin fan socket	3123-5		
Silicone tube	2218		
VC20 Natural gas (G20) or Propane (G31) only			
Fan orifice plate assembly	200191		
Pressure switch (SIT or EAC)	M101355		
VC20 Natural gas (G20) only			
3.8mm injector	2290		
Burner orifice plate	200520		
Burner support spinning	200568-SUB		
VC20 Propane (G31) only			
2.3mm injector	2281-2		
Burner orifice plate	3161-2MF		
Burner support spinning	200521-SUB		

18 Method for calculating equivalent flue resistance – Appendix 1

Component	Internal Size (mm)	Resistance factor (Ke)	
Pipe	100	0.78	per meter
	125	0.25	
90° bend	100	1.22	per fitting
	125	0.5	
135° bend	100	0.61	per fitting
	125	0.25	
Terminal	100GCI	0.6	per fitting
	125 GCI	0.25	

Inlet resistance of flue (Ki)		Outlet resistance of flue (Ko)	
100mm spigot	2.5	100mm flue	2.5
125mm spigot	1.0	125mm flue	1.0

The formula for calculating the equivalent flue size is as follows:

$$H_e = H_a \times \frac{(K_i + K_o)_e}{(K_i + K_o)_a - K_e H_a + \sum K}$$

where

H_e is the height of the equivalent flue

H_a is the vertical height of the actual or proposed flue measured from the flue spigot

K_i is the inlet resistance of the flue

K_o is the outlet resistance from the flue

subscript 'e' refers to the equivalent flue diameter

subscript 'a' refers to the actual or proposed flue diameter

K_e is the resistance per unit length of the equivalent flue

$\sum K$ is the resistance (other than the inlet and outlet resistances) of the actual or proposed flue

Note K and $\sum K$ are obtained from the table above

Example

	100mm diameter	125 diameter
inlet resistance of actual flue	2.5	1
outlet resistance of actual flue	2.5	1
inlet resistance of equivalent flue	1	1
outlet resistance of equivalent flue	1	1
is the vertical height of the actual or proposed flue measured from the flue spigot	7	7
other resistances of actual flue		
terminal (1)	0.6	0.25
90° bend (0)	0	0
135° bend (0)	0	0
flue pipe	5.46	1.75
	6.06	2
$H_e =$	2.50	6.22

Note 1m of actual flue (with two 90° bends) gives the minimum equivalent flue height of 0.25m (for 100mm diameter flue) and 0.62m (for 125mm diameter flue).

The maximum equivalent flue height for 100mm diameter flue is 2.50m and for 125mm diameter flue the maximum equivalent flue height is 6.22m (with two 90° bends).

Ambi-Rad stocks an extensive range of flue pipe and accessories that are compatible with the cobra range of heaters. For details contact our Sales Department.

Figure 30 Example layout of a typical flue arrangement

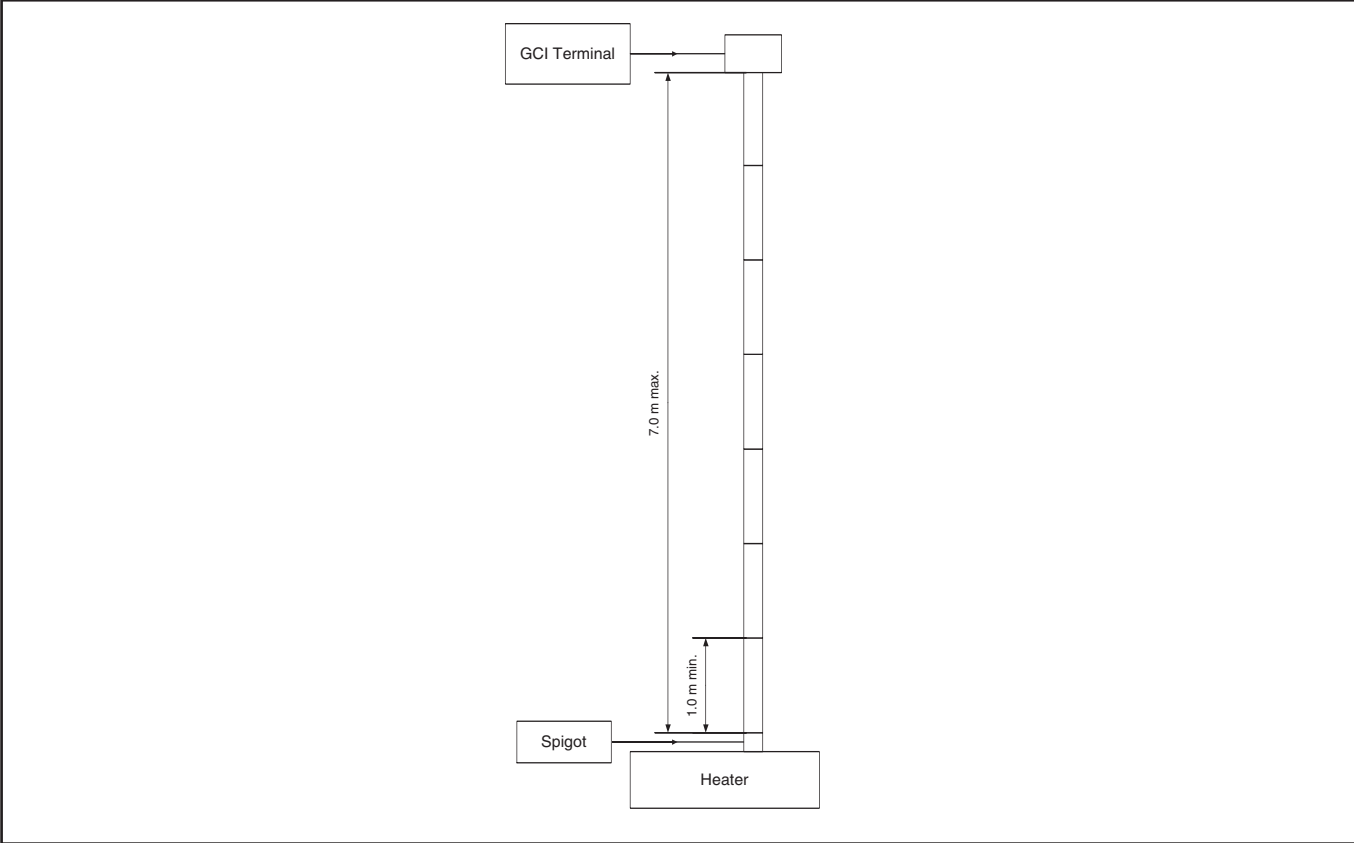

19 User instructions for Ambi-Rad Vision Compact series of heaters

Vision Compact is an overhead radiant heating system for industrial and commercial buildings. The Vision Compact heater is suspended horizontally overhead from the roof or inclined mounted at 30° to 45° from the horizontal and heats by radiation in the same way as the sun.

20 Important Information

1. This appliance must only be installed by a competent person in accordance with the requirements of the Codes of Practice or the rules in force.
2. Warning this appliance must be earthed.
3. Never rest anything, especially ladders, against the heater.

To start the Vision Compact heater

1. First ensure that the gas supply to the heater is turned on.
2. Ensure that the settings of any time-switch and thermostat are such that the heating system will be required to operate.
3. Switch on electrical supply to heater. Mains light, coloured red will illuminate and ignition sequence will commence.
4. After completion of an air purge period, ignition of the burner will occur and burner light, amber, will illuminate.
5. If lock out occurs, switch off electrical supply, wait 15 seconds then switch on again. If lock out occurs again switch off heater and call out a service engineer.

Note U bend will glow, but this is acceptable.

To switch off Vision Compact heater

1. Switch off electrical supply to the heater. The burner will shut off and the fan will stop.
2. If the heater is switched off for periods in excess of one week, it is highly recommended that both gas and electrical supplies are turned off.

Servicing

To ensure continued efficient and safe operation it is recommended that the heater is serviced regularly by a competent person e.g. every year in normal working conditions but in exceptionally dust or polluted conditions more frequent servicing may be required. The manufacturer, whose address is given below, offers a maintenance service. Details available on request.

The data plate (supplied) should be attached on, or adjacent to a low level user control, as it contains the instructions for the safe operation of the appliance including its lighting and shut-down procedures.



Ambi-Rad Limited Fens Pool Avenue
Brierley Hill West Midlands
DY5 1QA United Kingdom

Telephone 01384 489700
Facsimile 01384 489707
UK sales email sales@ambirad.co.uk
Website www.ambirad.co.uk

AMBIRAD is the registered
trademark of Ambi-Rad Limited.

Due to continuous product
innovation, Ambi-Rad reserves
the right to change product
specification without due notice.

Document reference number : GB/COB/112/0905

AMBIRAD
ENERGY EFFICIENT HEATING SYSTEMS



An Ambi-Rad Group company

