



AMBIRAD

COBRA

COBRA

GAS FIRED RADIANT
TUBE HEATERS

Operation, maintenance
and servicing manual
CB40

Index

- 1 Gas supply/connection/technical data
- 2 Electrical connection
- 3 Fan assembly
- 4 Cobra herringbone gas radiant heaters
- 5 Health & safety
- 6 Installation - suggested methods of heater suspension
- 7 Minimum mounting heights and clearances
- 8 Installation of Cobra heaters
- 9 Flue connection
- 10 Access to the burner gas/flue/electrical connection
- 11 Fresh air ducted inlet (all models)
- 12 Commissioning for individually flued and unflued heaters
- 13 Routine service
- 14 Herringbone adjustment
- 15 Replacement of components
- 16 Trouble shooting checks
- 17 Spare Parts
- 18 Method for calculating equivalent flue resistance - Appendix 1
- 19 User instructions for Ambi-Rad Cobra of heaters



1 Gas supply/connection/ technical data

This heater is for use on:-

Natural gas G20, 20 mbar.

The gas connection on the Cobra heater is R¹/₂ (1/2 in. BSP internal thread).

Natural gas

Max supply pressure 25 mbar

Min supply pressure 17 mbar

Correct burner gas pressure is indicated in the table below.

To gain access to the gas connection, see section 10.

Ambi-Rad heaters must be installed in accordance with the relevant provisions of the Gas Safety (Installations and Use) Regulations 1998. Due account should also be taken of any obligations arising

from the Health and Safety at Works Act 1974. In addition the installation must be carried out in accordance with the current IEE 1992 (BS 7671), BS 6896:1991 (Industrial & Commercial) and any other relevant British Standards and Codes of Practice.

A gas meter is connected to the service pipe by the local gas region or a qualified local gas region contractor. An existing meter should be checked preferably by the Gas Region or a qualified local gas region contractors to ensure that the meter is adequate to deal with the rate of gas supply required. Installation pipes should be fitted in accordance with BS 6891:1998, such that the minimum pressure at least (Please see the technical data table below) will be achieved and any other British Standards and Codes of Practice.

Pipes of smaller size than the heater inlet gas connection should not be used.

The complete installation must be tested for soundness as described in the previous standard.

The gas supply must not be in the position where it is subject to overheating.

The gas union service cock MUST be fitted in the gas supply close to the heater, but not onto the burner.

It is essential to provide some flexibility in the final gas connection by use of a tested and certified metallic hose to BS 6501 Part 1:1991 (minimum acceptable quality Type 'B' Class 1). When stainless steel flexible hoses are used the hose should be connected in a 180° (bend without any strain or torsion). (See figure 1 overleaf).

Note: Take care when making a gas connection to the heater not to apply excessive turning force to the internal controls.

Technical data

Injector gas pressure

Model	Natural Gas G20
CB40	11.8 mbar

Model	CB40
Nominal heat input gross Natural Gas (G20) kW	38
Injector size	7 holes @dia 2.4
Number of injectors	1
Gas flow rate m ³ /hr	3.6
Gas supply	Connection R ¹ / ₂ 1/2 BSP external thread
Gas pressure Natural Gas (G20)	max. 25.0 mbar - min 17.0 mbar
Electrical supply	230 Volts 1 phase 50 Hz
Current rating	0.55 amps max. (inductive)
External fuse rating	3 amps
Ignition	Electronic programme start-up with spark ignition
Noise level dBA @ 3m 'free field'	40
Dimensions mm	2298L x 1865W x 256D
Flue diameter OD	125mm
Ducted air diameter OD	102mm
Total installed weight kg	152
Minimum mounting height m	5.7
Electrical motor details	V220 ac 50Hz Class F
Fan rating	0.5A

Figure 1 Correct installation of flexible gas connection

Corrugated Flexible Metallic Hose Assemblies to BS 6501 Part 1 1991 Class 1 Type C
Construction 1 m long – Ambi-Rad Part No. 6500-2

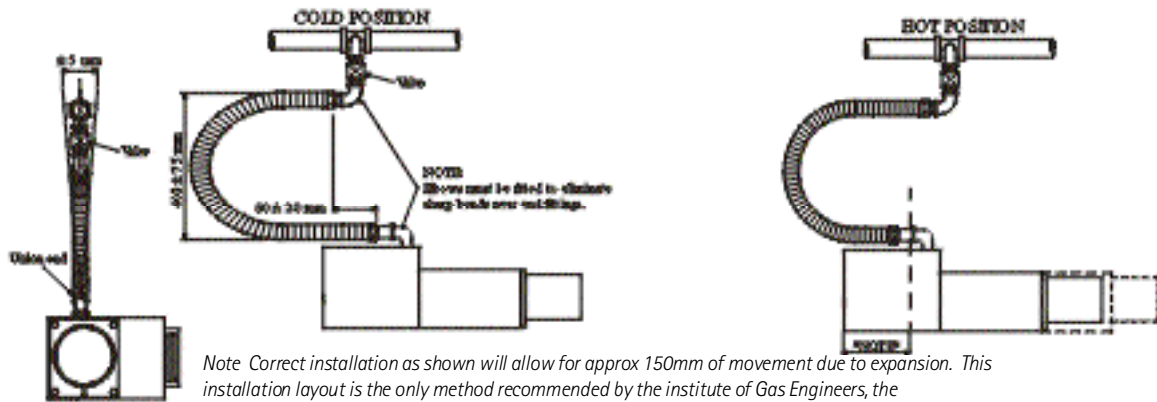

Note Correct installation as shown will allow for approx 150mm of movement due to expansion. This installation layout is the only method recommended by the institute of Gas Engineers, the manufacturer and Ambi-Rad Ltd. These instructions must be carried out in accordance with the relevant provisions of the gas safety (installation and use) regulations 1991 (as amended) and the manufacturers recommendations.

Corrugated Flexible Metallic Hose Assemblies to BS 6501 Part 1 1991 Class 1 Type C
Construction 600 m long – Ambi-Rad Part No. 6500

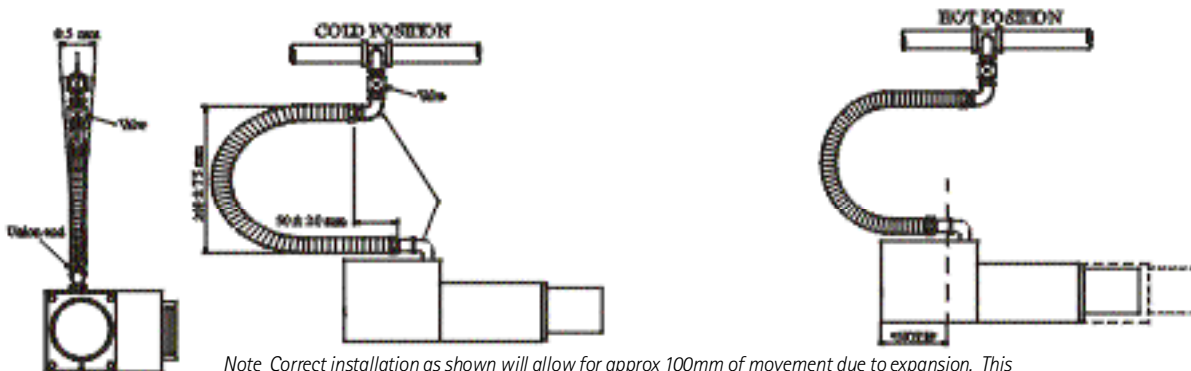

Note Correct installation as shown will allow for approx 100mm of movement due to expansion. This installation layout is the only method recommended by the institute of Gas Engineers, the manufacturer and Ambi-Rad Ltd. These instructions must be carried out in accordance with the relevant provisions of the gas safety (installation and use) regulations 1991 (as amended) and the manufacturers recommendations.

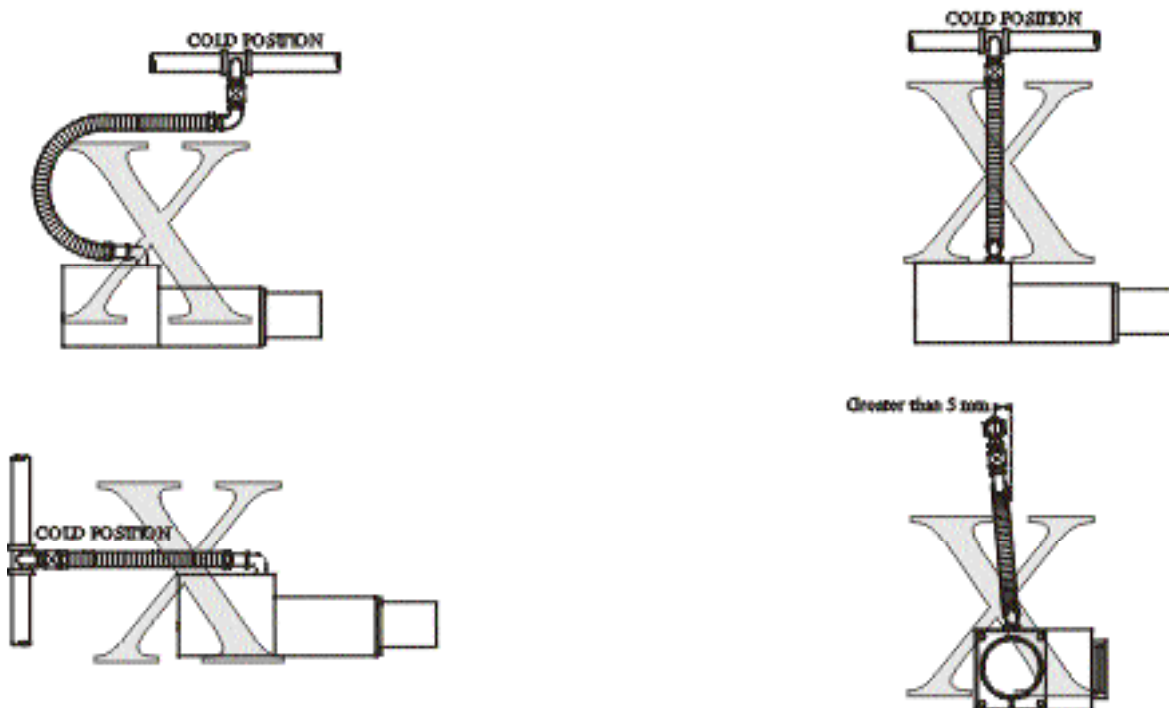

2 Electrical connection



This appliance must be earthed.

Supply 230V 50Hz single phase.

Current rating 0.55 amp max (inductive).

Fuse: external 3 amp.

All electrical work should be carried out to IEE standards by a competent electrician. The electrical connection to the heater is made by means of a three pin plug-in power connector. Live, neutral and earth connections should be made via a flexible supply cable to the power connector and routed clear of the heater or tubes. The flexible supply cables should be of 0.5mm² complying with BS 6500:1990.



Wiring

The wires in the mains lead are coloured in accordance with the following code:

Green & Yellow Earth

Blue Neutral

Brown Live

Instructions for connecting mains lead to the plug:

Connect the green and yellow to plug terminal marked E. Connect the blue wire to terminal marked N. Connect the brown wire to terminal marked L.

It is recommended the electrical circuit controlling the heater or group of heaters incorporates thermostats, a time switch and if required manual control switches and a frost thermostat.

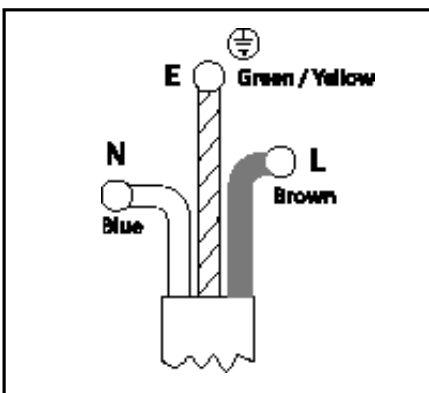

Circuits and controls

All such controls and switchgear must be rated to handle the total inductive load of the circuit they control. Load per Ambi-Rad heater is 0.55 amp. For large installations, the use of relays and contactors should be considered. The method of connection to the electrical supply must facilitate complete isolation and should be made via a fused double pole isolator and should be made via a fused double pole isolator having a contact separation of at least 3mm in all poles and supplying the appliance only.

Alternatively, connection may be made via a fused three pin plug and un-switched shuttered socket, both complying with the requirements of BS 1361:1971 (1986). Ensure that a copy of the lighting instructions plate is affixed adjacent to the electricity supply switch. Should this switch serve more than one heater it is only necessary to affix one copy per service.

Thermostats and other controls

For details on the use and siting of thermostats (if used) refer to Ambi-Rad leaflets Doc Ref GB/CON/002/0902.

Figure 2 Typical external wiring

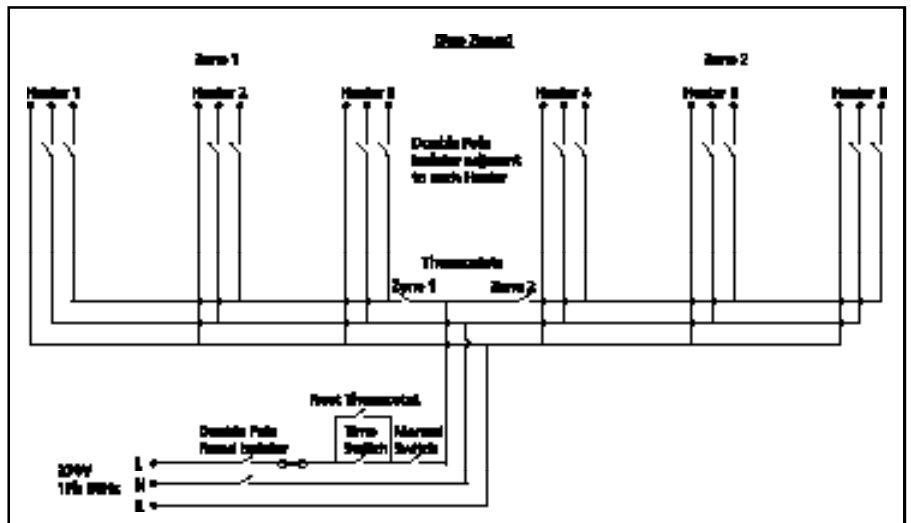

Note For more comprehensive control arrangements see black bulb and control panel leaflets.

Figure 3 Internal wiring diagram

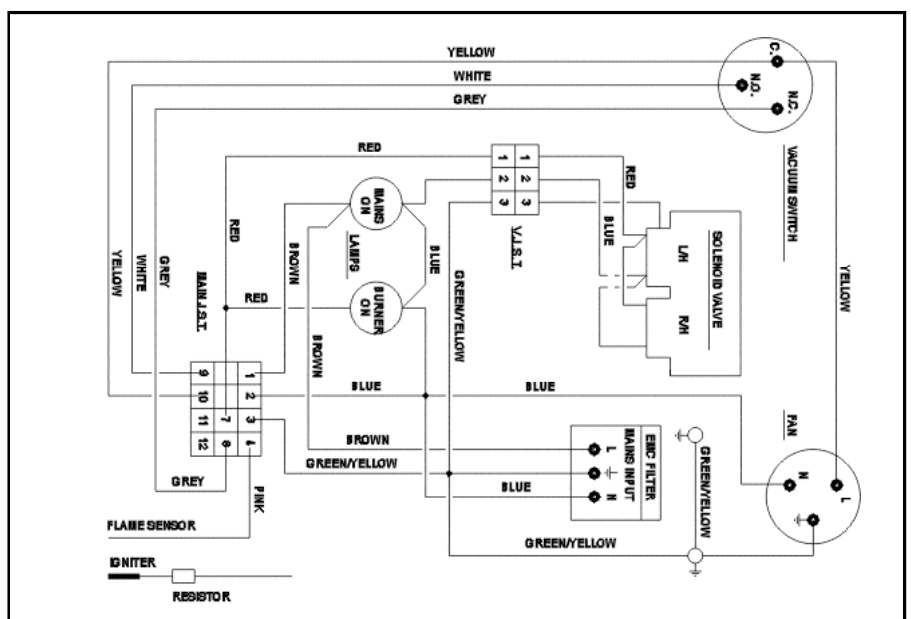

3 Fan assembly

Note: For both horizontal and inclined mounting the fan assembly must be perfectly vertical with the fan outlet facing upwards.

For unflued heaters (UK Only) a fan baffle must be attached to the fan outlet. (Part No 201301)

4 Cobra herringbone gas radiant tube heaters

For herringbone heaters refer to the relevant information leaflet (GB/HB/134/0402).

A herringbone system allows several Cobra heaters to be operated by one combustion fan. This has the benefit of only one building penetration being required when flueing the products of combustion.



5 Health & safety

Ambi-Rad Limited cannot be responsible for ensuring that all site safety procedures are adhered to during assembly and installation. Sole liability rests with the installer.

6 Installation – suggested methods of heater suspension

Attachment to the heater support lugs should be made by either a 'speed link', D shackle, nut bolt and large washer, or in the case of drop rods, a closed formed hook. The hanging attachments to overhead steelwork etc. must be purpose made to good sound engineering practice or of a proprietary type fixing. They must be adequately fixed and designed to carry the whole weight of the heater, unpacked 152kg.

In the event of suitable roof steelwork not being available, additional steelwork should be fitted to enable vertical hangers to be used for suspending the heaters.

If there are any doubts as to the strength or suitability of roof steelwork to which heaters are to be suspended, please refer to consultant / architect / owner of the building.

7 Minimum mounting heights and clearances

The recommended minimum mounting heights, along with the recommended clearance to combustibles for the Cobra range of heaters is shown in the table below.

Clearances 1

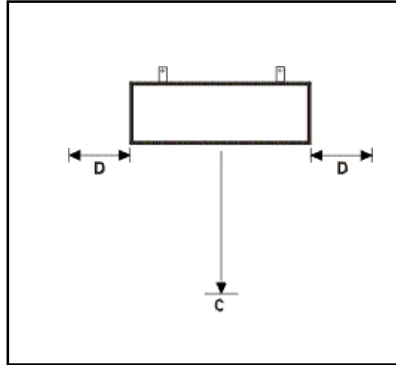

Clearances 2

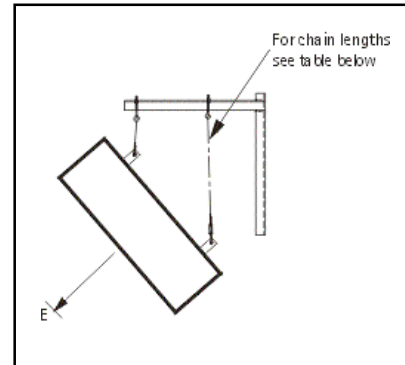

Clearances 3

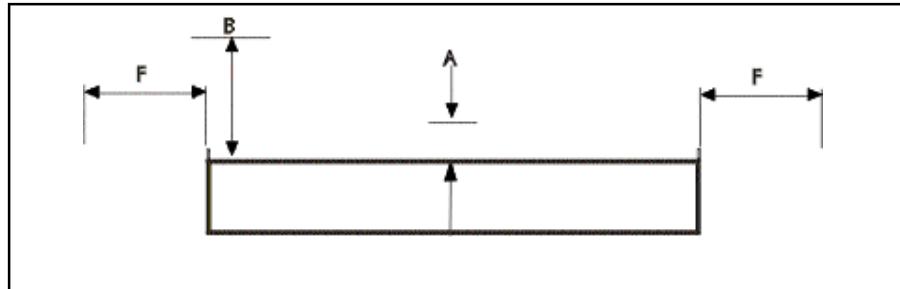

Model	Required angle	Additional chain length (mm)
All models	30°	575
	45°	730

Minimum recommended mounting heights

Model	Horizontal (m)	Inclined 30° (m)	Inclined 45° (m)
CB40	5.7	5.3	5.3

Clearance distances

Model	CB40
A. Above reflector (fan unflued)	680
B. Above burner/fan assembly unflued	680
C & E Beneath tubes	2300
D. To the sides	1300
B. Above reflector and fan outlet flued	500
F. From ends	940

All dimensions are in millimetres

8 Installation of Cobra heater

Health & safety

A qualified installer is required to install the appliance in accordance with the rules in force, and should the need ever arise to convert the appliance for use with other gases.

Installation

There is no on site assembly required for the COBRA heater.

Attach an appropriate hanging attachment to each of the six hanging brackets.

The heater can be installed with the packaging in place to protect the casing from damage during installation.

Raise the heater into the air and affix to the chain previously located of 4mm (minimum) gauge galvanised welded link construction. Alternatively, 10mm diameter mild steel drop rods can be used.

Wall mounting brackets must support the heater at an angle of inclination between 30° and 45°, and are available from the manufacturer. The angle can be varied by adjusting the drop rods or chain on each bracket. The bracket positions are critical and when suspended they should have the same orientation i.e. all the same angle.

Note When installing the heater at an angle the combustion fan outlet should be positioned so that it remains vertical.

It is recommended that sufficient clearance from any fixed structure (e.g. a wall) is given above the burner and behind the burner fan compartment to allow sufficient room for the service of the heater. (See section 7 on clearance distances).

Note As a part of the heaters annual service all dust deposits on the top of the reflector should be removed before the start of each heating season.

Figure 4 Mounting of Cobra heater

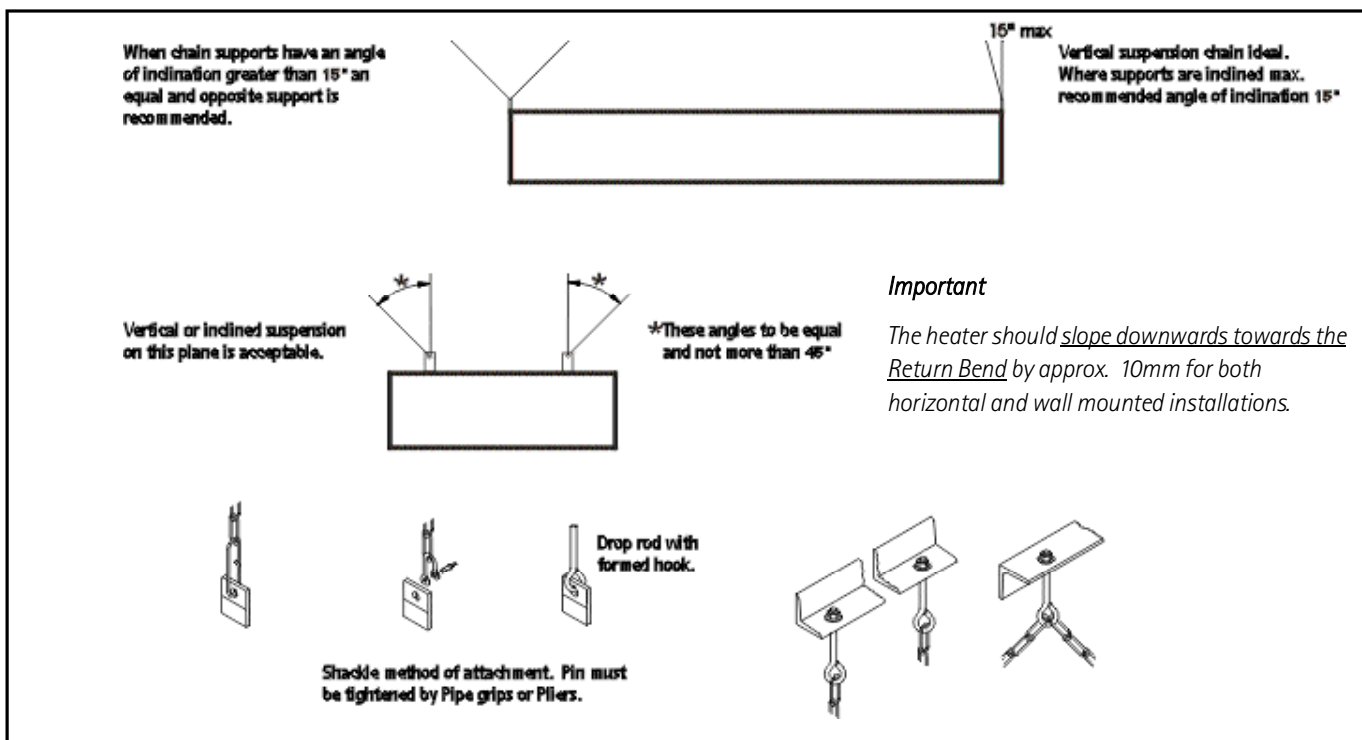

9 Flue connection

Flue technical details

Model	CB40
Gas type	Natural Gas (G20)
Mass flow rate of flue gases (kg/s)	0.0185
Flue gas temperature (°C) @ flue outlet	240
Flue pressure (Pa) Positive	120

Figure 5

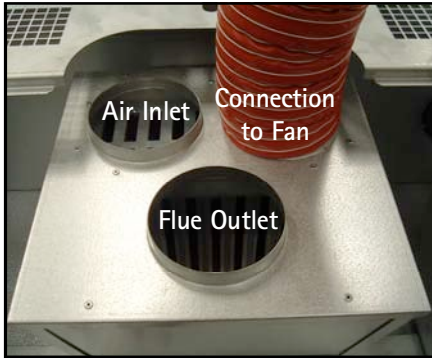

The flexible duct supplied MUST be fitted between re-circulation air and fan spigot with pipe clamps as provided.

The Cobra heater may be installed with or without a flue to the atmosphere providing the air supply and building ventilation requirements as stated in BS 6896: 1991 are complied with and providing due consideration is given to the possibilities of condensation forming on cold surfaces when used as an unflued heater.

Unflued installation

For unflued heaters (UK Only) a fan baffle must be attached to the fan outlet. (Part No 201301).

Permanent ventilation required is as follows:

Natural ventilation

(To be fitted at high and low level with minimum distance between 3m).

Low level, when air change rate is less than 33m³/h/kW of total rated input, either: 1.4cm² for each 1m³/h/kW below 33m³/h/kW or 46cm²/kW of total rated input.

High level, above areas where personnel are working is as above.

Mechanical ventilation

Minimum proven air flow is 33m³/h/kW of total rated heated input.

If the heater is installed without a flue, ensure that combustion gases do not impinge on combustible materials. The maximum permitted temperature for such materials is 50°C. EN416.

Flued installation

The Cobra heater may be installed with a fixed flue. A flue kit fitting (supplied as an optional extra by the manufacturer) must be fitted to the flue exit, this kit connects from the flue outlet to a 5" adaptor. The flue fitting is designed to accept either 5" single wall or 5" twin wall.

Propriety twin wall metal joints should be sealed with heat resistant caulking and faced off with fire cement.

The flue pipe should be adequately supported at regular intervals from the building structure and terminated externally with a British Gas Tested and Certified terminal.

The maximum flue length is 7m and the maximum number of bends is two on individually flued appliances. The flue may be installed vertically or horizontally, but must be terminated vertically. All connections in the flue pipe must be properly sealed.

Natural ventilation

(Preferably at low level)

Up to and including 60kW: 4.5cm²/kW.

Over 60kW: 270cm² + 2.25cm²/kW in excess of 60kW total rated input.

Forced ventilation

Minimum proven air flow is 2.35m³/h/kW of total rated input.

For detailed information please refer to BS: 6896:1991, Installation of Gas Fired Overhead Radiant Heaters for Industrial and Commercial heating (2nd and 3rd) family gases.

For calculation method for flue sizing see Appendix 1 on page 14.

For Herringbone flued heaters see section 14.

10 Access to the burner gas/flue/electrical connection

To gain access remove the six bolts securing the two sections of the ball guard to the heater and remove.

Figure 6



11 Fresh air ducted inlet (all models)

When the Cobra heater is to be installed in locations where there is airborne dust or where there is a polluted atmosphere e.g. chlorinated vapours, process dust etc., a ducted fresh air supply must be provided to the burner.

A fresh air duct of minimum 100mm (4in) diameter should be connected to the D/A duct. A flexible joining piece should be used, available from the manufacturer fixed with hose clips to facilitate disconnection when servicing the burner.

The maximum length of fresh air inlet duct is 7m of 100mm (4in) diameter duct, the maximum number of bends is two. The fresh air inlet duct can be installed either vertically or horizontally. A position should be selected for the inlet of the fresh air duct so that it will receive dust free clean air. A cowl of the British Gas tested and certified type, such as the GCI or GLC terminal, should be fitted at the inlet of the duct. If the duct inlet is located on a roof the underside of the inlet cowl must be at least 600mm (2ft) above roof level and at least 250mm (10in) higher than any projection on the roof within a 2m radius of the cowl.

12 Commissioning for individually flued and unflued heaters

Inspect installation and ensure that it has been carried out in accordance with these instructions. Ensure that electrical and gas supplies are isolated. The gas supply should be purged and tested for soundness in accordance with the BS6891:1988, BGIM/16, IGE Report 1M/2 and any other British Standard and Codes of Practice. Open isolating valve.

Remove the ball guard to heater (section 10) slacken screw securing burner box access cover. (See figure 7)

Ensure all internal components are securely fixed and all connections securely made. Switch on the electrical supply to the heater and observe the correct start up sequence as follows:

The mains lamp (red) will illuminate. The ID fan will start to run and the vacuum switch checking relay (inside flame electronic sequence control box) will pull in. Safe start checks are carried out automatically and a purge period of approximately 9 seconds will commence.

At the end of the purge period the ignition sequence will commence. The spark ignition will be energised producing a spark at the ignition electrode. The gas shut off valve will at the same time be energised. If ignition is successful the flame is detected by the flame sensing probe and the ignition spark will be switched off. The 'burner on' (amber) lamp indicates that the gas safety control valves are energised.

If the ignition is unsuccessful the gas safety control valve is closed and the spark ignition de-energised after approximately 5 - 7 seconds.

After an unsuccessful ignition attempt the electronic sequence controller will 'lock out'. The 'power lamp' (red) only will remain illuminated and the fan will continue to run.

To reset this 'lock out' condition, switch off the power supply to the heater, wait 5 seconds then restore it. If repeated lock out occurs investigate cause. (See Fault Finder section 16).

In the event of an electrical fault after installation of the appliance preliminary electrical systems checks should be carried

out (re earth continuity polarity and resistance to earth).

To shut down the heater, switch off the power supply to the heater. Automatic control of the heater or a series of heaters may be achieved by incorporating thermostats, time switches, frost thermostats, manual over-ride switches etc, in the electrical supply to the heater(s). It is essential to allow a delay of 15 seconds after switching off a heater before attempting to restart.

If at any time after completion of the start up sequences, loss of flame should occur, the electronic sequence controller will attempt to re-ignite. If this is unsuccessful lock out will occur.

Set burner gas pressure as follows:

Isolate gas supply. Unplug mains input connector to heater.

Unscrew the fixing screw in the housing lid and remove. Remove pressure test point screw nearest the burner head and connect a 'U' tube manometer to the pressure test nipple located on the body of the gas valves. Remove the slotted cover from the pressure test regulator revealing the adjustable screw. Replace mains input connector and start the heater.

Figure 7



Using a suitable screwdriver adjust and slacken the securing screws to hinge burner access cover.

Figure 8

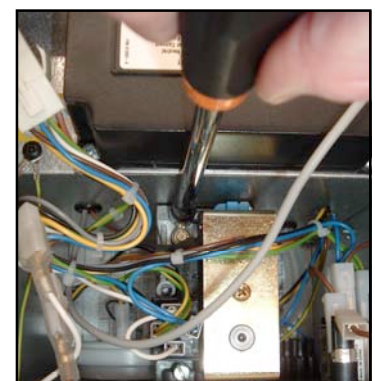

Slacken pressure test point screw nearest the burner head and connect a 'U' tube manometer to the pressure test nipple located on the body of the gas valve. (See figure 8).

Access to the pressure regulator adjustable screw is via a hole in the side of the burner box.

Figure 9

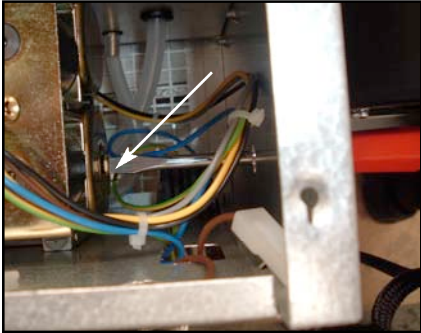

Replace mains input connector and start the heater. Using a suitable screwdriver adjust the pressure regulator if necessary set pressure as stated on data label.

Switch off the heater by pulling out the mains input connector. Disconnect 'U' tube manometer and tighten screw in pressure test nipple.

Check the operation of the flame safe guard equipment as follows:

With the heater running normally, switch off the gas supply at the appliance isolating the valve. Check the operation of the vacuum proving switch as follows;

With the heater running observe that the 'burner on' lamp extinguishes within one second. After a purge period of approximately 9 seconds the heater should attempt to re-light and if the gas isolating valve has been left off, lock out should occur indicated by power light only being illuminated and fan running.

Check the operation of the vacuum proving switch as follows. With the heater running normally pull out the three pin fan connection plug, thus causing the fan slow down and stop. Within 3 seconds the burner should shut off.

Observe for at least 20 seconds that there is not attempt to re-ignite, then replace the three pin plug and observe that the heater proceeds to ignite in the normal way.

Hand the 'User Instructions' to the user and explain how to operate the heater and controls.

Leave the 'Installation and Servicing Instructions' at the users meter or preferably with the service / maintenance engineer / manager for use on future service calls.

Note Heaters have a tendency for the tube and 'U' bend to glow. This is normal and quite acceptable.

13 Routine service

Frequency of servicing

The manufacturer recommends that to ensure continued efficient and safe operation of the Cobra it is recommended that the heater is serviced regularly by a competent person e.g every year in normal working conditions but in exceptional dusty or polluted conditions more frequent servicing may be required. The manufacturer offers a maintenance service. Details are available on request.

Tools required for servicing

The tools required to carry out any servicing of the Cobra range of heaters are as follows; electrical screwdriver, 13mm spanner, 10mm spanner, 8mm spanner, cross head screwdriver, flat blade screwdriver, adjustable spanner, pipe wrench, soft bristle brush; and a soft cloth.

Health and safety

Isolate gas and electrical supplies before carrying out any repair work. Always test for gas soundness with a suitable leak detection fluid.

To remove the burner assembly proceed as follows;

Remove the fixing screws securing the ball guard. (See section 10).

Figure 10



Drop down access door on front of heater by releasing the quarter turn fixings.

Figure 11

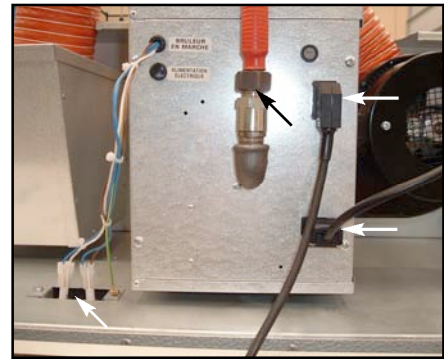

Unplug the mains and fan leads from the burner assembly. Disconnect wiring to neon lamps. Disconnect the gas feed pipe at the gas valve.

Figure 12



Slacken the pinch screws at the front of the burner securing the burner to the heater firing leg. Remove flexible ducting to fan by slackening hose clamp.

Figure 13



Slide the burner assembly back towards the front of the product until the burner spigot disengages from the firing tube. Slide the burner assembly away from the product.

Combustion fan

To remove the combustion fan disconnect the electrical connection from the burner/control assembly and remove the fan securing screws to the side of the burner box.

Figure 14



Figure 15

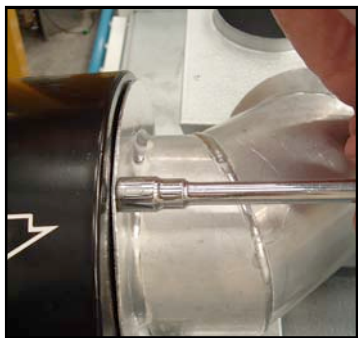

Remove fan spigot by removing the three retaining screws.

Inspect the fan impeller and remove any dust by brushing with a soft brush. Similarly remove any dust from the finger guard covering the secondary (cooling) impeller and the mesh aperture in the motor cover. Ensure that the impeller turns freely and that there is no excessive play in the bearings.

Figure 16



Emitter tube inspection

Brush away any dust on the exterior of the emitter tubes.

Remove the heat exchanger by slackening pinch bolts disconnect flue and fresh air inlet where necessary.

Through the two holes view down the tubes and if carbon deposits are evident clean with a suitable rod.

Reflector

It is recommended that the reflector is cleared of any dust annually and or before the start of each heating season.

The reflector can be cleaned with a soft cloth and detergent in water. A mild non abrasive metal polish may be used in cases of extreme discolouration. Dirty reflectors will increase the heat radiation upwards into the roof space by 3-4%.

Sweeping of flue

As a part of the annual service of type B appliances the flue should be periodically swept in accordance with the regulations of the country that the appliance is installed.

For servicing of injector, electrode assembly, refer to Section 13.

14 Herringbone adjustment

Gain access to the burner/flue compartment, attach the orange flexible pipe to the flue outlet (See figure 17) with the pipe clamp provided.

Figure 17



Connect the damper to the opposite end of the orange flexible pipe, attach with the pipe clamp.

Connect a 4" flue pipe to the damper (not supplied) to the herringbone system.

Connect the flexible pipe from the air return on heat exchanger to the burner inlet, secure with pipe clamps. See figures 18 and 19.

Figure 18



Figure 19

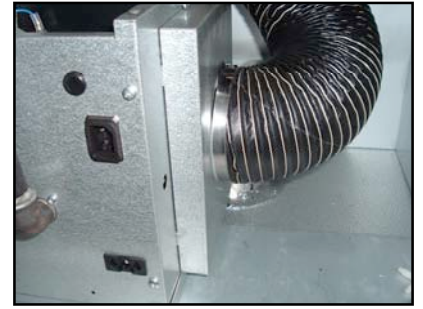

Connecting to a herringbone adjustment

Disconnect the electric supply, gain access to the burner, see section(s) 10 to 12

Figure 20

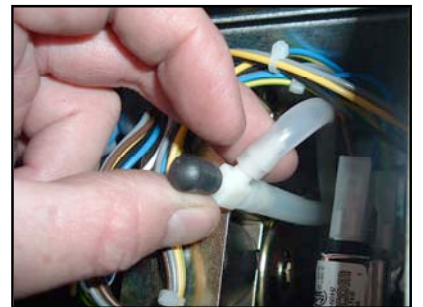

Locate pressure test tee piece, remove the black sealing cap. See figure 20.

Attach the manometer. See figure 21.

Figure 21

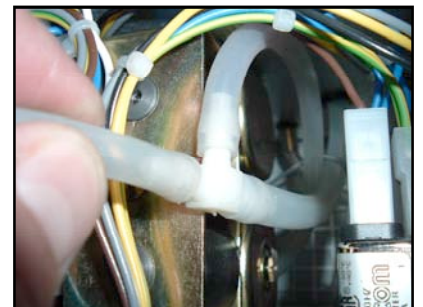

Loosen the damper plate locking, grub the screw, slide the damper plate to approximately half way.

Follow commissioning procedure, allow heater to fire for approximately 30 minutes. Set damper plate to give a hot pressure as indicated below. Check gas burner pressure. To gain access to gas pressure adjustment see section 12

Damper setting Hot	Burner Gas Pressure
1.2mb	10.5mb

Turn off electrical supply, remove manometer, refit sealing cap.

15 Replacement and servicing of components in the burner assembly

Figure 17 Cobra burner assembly

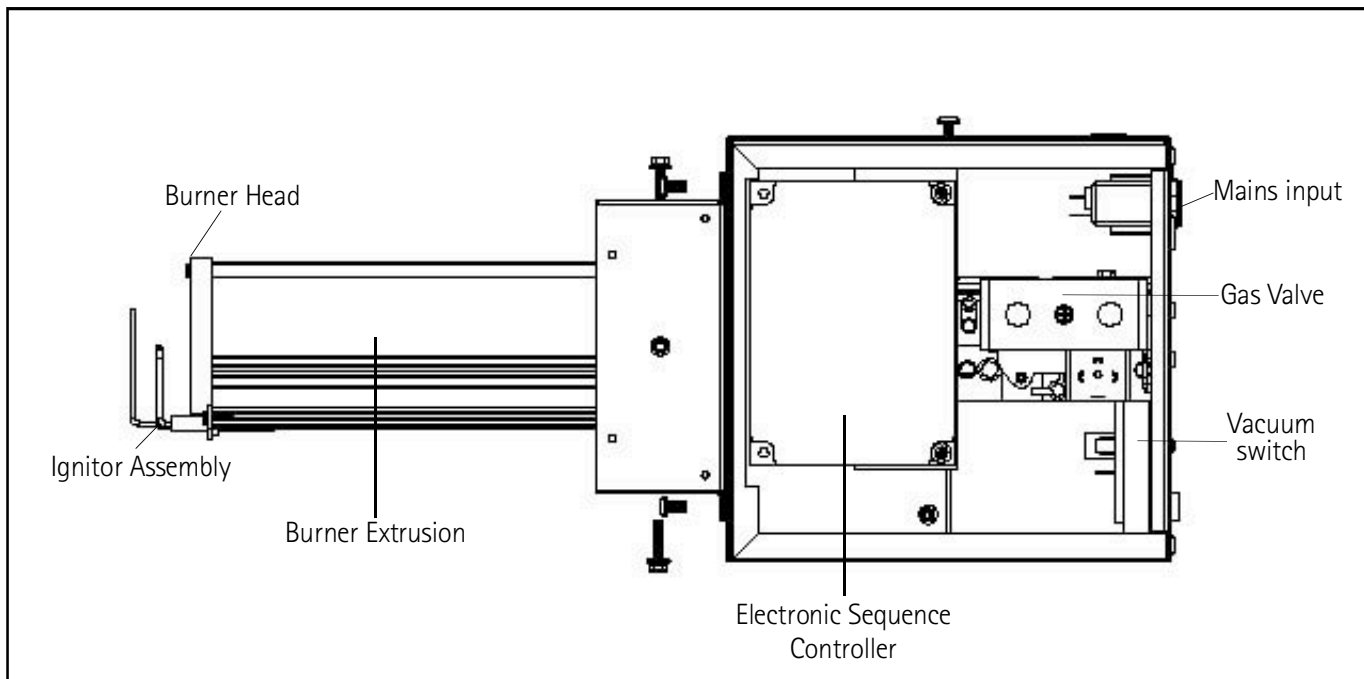

Health and safety

Isolate gas and electrical supplies before carrying out any repair work. Always test for gas soundness with a suitable leak detection fluid.

Replacement parts

Any spare part components that are not approved by Ambi-Rad could invalidate the approval of the appliance and operation of the warranty.

It is recommended that the burner assembly is removed from the product to facilitate replacement of the following components:

- Burner head
- Injector
- Gas valve
- Electrode assembly
- Electronic sequence controller
- Vacuum switch

To remove the burner please see section 13.

With the burner assembly removed from the product it is now possible to replace components as follows;

Injector

Figure 18

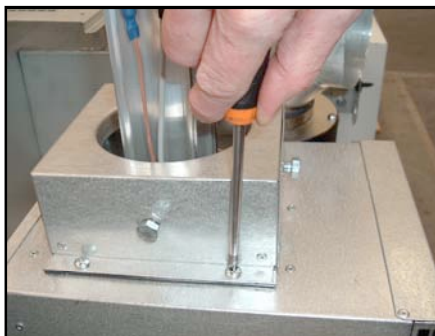

Remove the four screws securing the burner spigot to the burner box. Lift off the burner assembly and gasket, checking the gasket for signs of splitting, and replace as required.

Figure 19

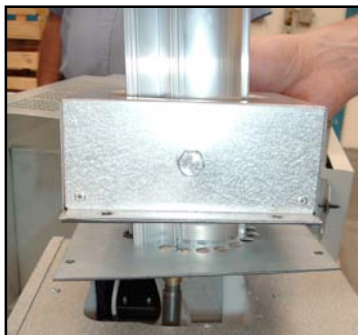

Lift off burner assembly carefully as electrode leads and vacuum tubes are still attached.

Figure 20



Slacken with a spanner, then unscrew the injector from its carrier. If servicing the injector, blow through orifice, never drill or broach out or use wire to clean. Replace if blocked or damaged.

Re-fit components in reverse order of removal.

Electrode assembly

Figure 21



Remove the two screws securing the electrode assembly. Disconnect the leads, and remove. Check for cracked or damaged ceramic. Clean or replace as necessary. Re-fit components in reverse order of removal. On service or replacement of the electrode assembly check the spark electrode gap is 3.5mm + or -0.5mm.

Burner head

Figure 22

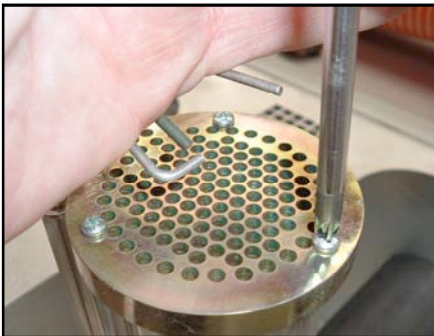

Remove three screws. Clean or replace as necessary.

Gas valve

Follow instructions for replacement of burner head and injector then proceed as follows:

Figure 23

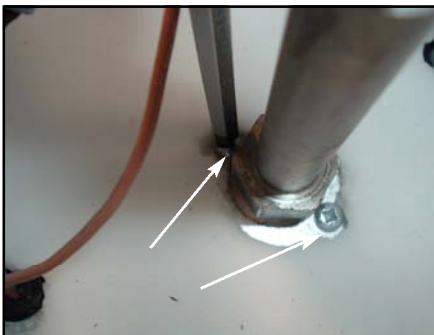
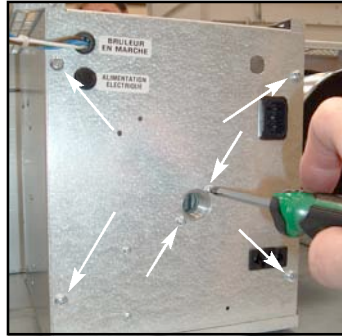

Figure 24



Disconnect gas fittings, disconnect wiring harness from valve. Remove rear panel of burner box. Remove the two screws securing the gas valve to the panel and two screws securing valve to burner box. Withdraw gas valve. remove injector carrier. Replace gas valve. Re-fit components in reverse order of removal. For correct operation follow instructions for commissioning of heater.

Electronic sequence controller

Figure 25

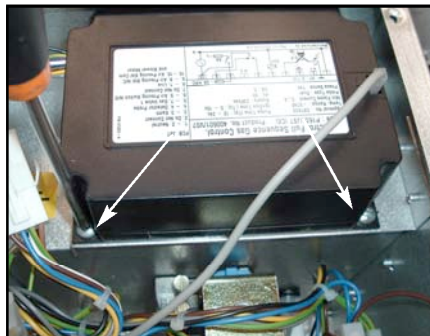

Disconnect the electrical connector from the controller to the wiring harness and the ignition high tension lead.

Remove the two screws and replace the controller.

Re-fit in reverse order of removal ensuring electrical connections are made.

Vacuum switch

Figure 26



Disconnect the two silicon rubber tubes and the electrical connectors. Noting correct orientation.

Figure 27

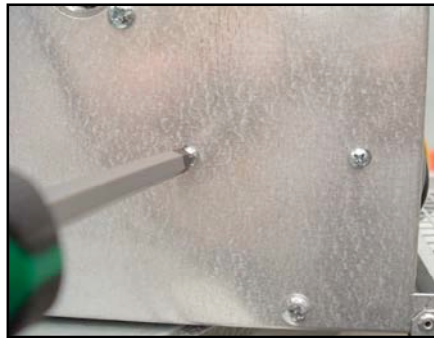

Remove the two screws securing the vacuum switch in position. Refit components in reverse order of removal.

Figure 28 S.I.T vacuum proving switch connections

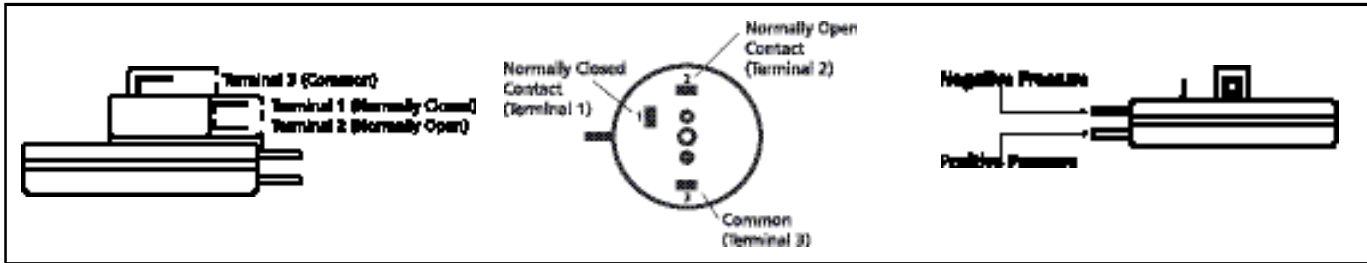

16 Trouble shooting checklist

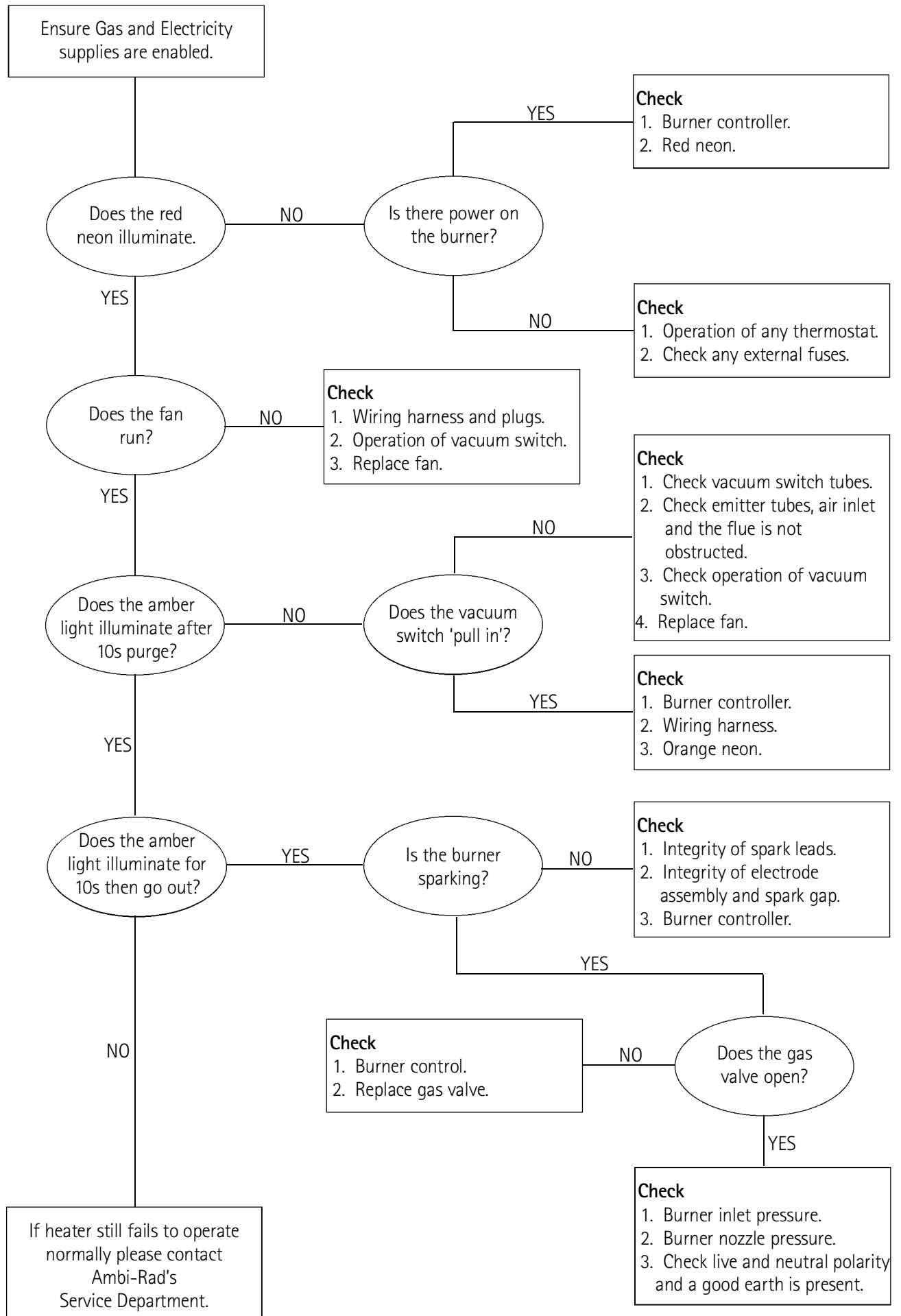

17 Spare parts

Description	Part Number
Igniter probes	201284
Burner head	200974
Orifice plate gaskets	201069 + 201208
Combustion fan	2501
Pactrol control box	2015
Gas valve	2052
Red neon	2180
Amber neon	2175
Wiring harness	900224
Neon lamp wiring harness	200254
Burner head wiring assembly	900225
3 pin mains socket	2135-5
3 pin fan socket	3123-5
Silicone tube	2198
Fan air inlet	201125
Burner orifice plate	201063-08
Injector	201007-24
Vacuum switch	201013

18 Method for calculating equivalent flue resistance – Appendix 1

Component	Internal Size (mm)	Resistance factor (Ke)	
Pipe	100	0.78	per meter
	125	0.25	
90° bend	100	1.22	per fitting
	125	0.5	
135° bend	100	0.61	per fitting
	125	0.25	
Terminal	100GCI	0.6	per fitting
	125 GCI	0.25	

	Inlet resistance of flue (Ki)		Outlet resistance of flue (Ko)
100mm spigot	2.5	100mm flue	2.5
125mm spigot	1.0	125mm flue	1.0

The formula for calculating the equivalent flue size is as follows:

$$H_e = H_a \times \frac{(K_i + K_o) e}{(K_i + K_o)_a - K_e H_a + K}$$

where

H_e is the height of the equivalent flue

H_a is the vertical height of the actual or proposed flue measured from the flue spigot

K_i is the inlet resistance of the flue

K_o is the outlet resistance from the flue subscript 'e' refers to the equivalent flue diameter subscript 'a' refers to the actual or proposed flue diameter

K_e is the resistance per unit length of the equivalent flue

K is the resistance (other than the inlet and outlet resistances) of the actual or proposed flue

Note K and K_e are obtained from the table above

Example

	100mm diameter	125 diameter
inlet resistance of actual flue	2.5	1
outlet resistance of actual flue	2.5	1
inlet resistance of equivalent flue	1	1
outlet resistance of equivalent flue	1	1
is the vertical height of the actual or proposed flue measured from the flue spigot	7	7
other resistances of actual flue		
terminal (1)	0.6	0.25
90° bend (0)	0	0
135° bend (0)	0	0
flue pipe	5.46	1.75
	6.06	2
He =	2.50	6.22

Note 1m of actual flue (with two 90° bends) gives the minimum equivalent flue height of 0.25m (for 100mm diameter flue) and 0.62m (for 125mm diameter flue).

The maximum equivalent flue height for 100mm diameter flue is 2.50m and for 125mm diameter flue the maximum equivalent flue height is 6.22m (with two 90° bends).

Ambi-Rad stocks an extensive range of flue pipe and accessories that are compatible with the cobra range of heaters. For details contact our Sales Department.

Figure 29 Example layout of a typical flue arrangement

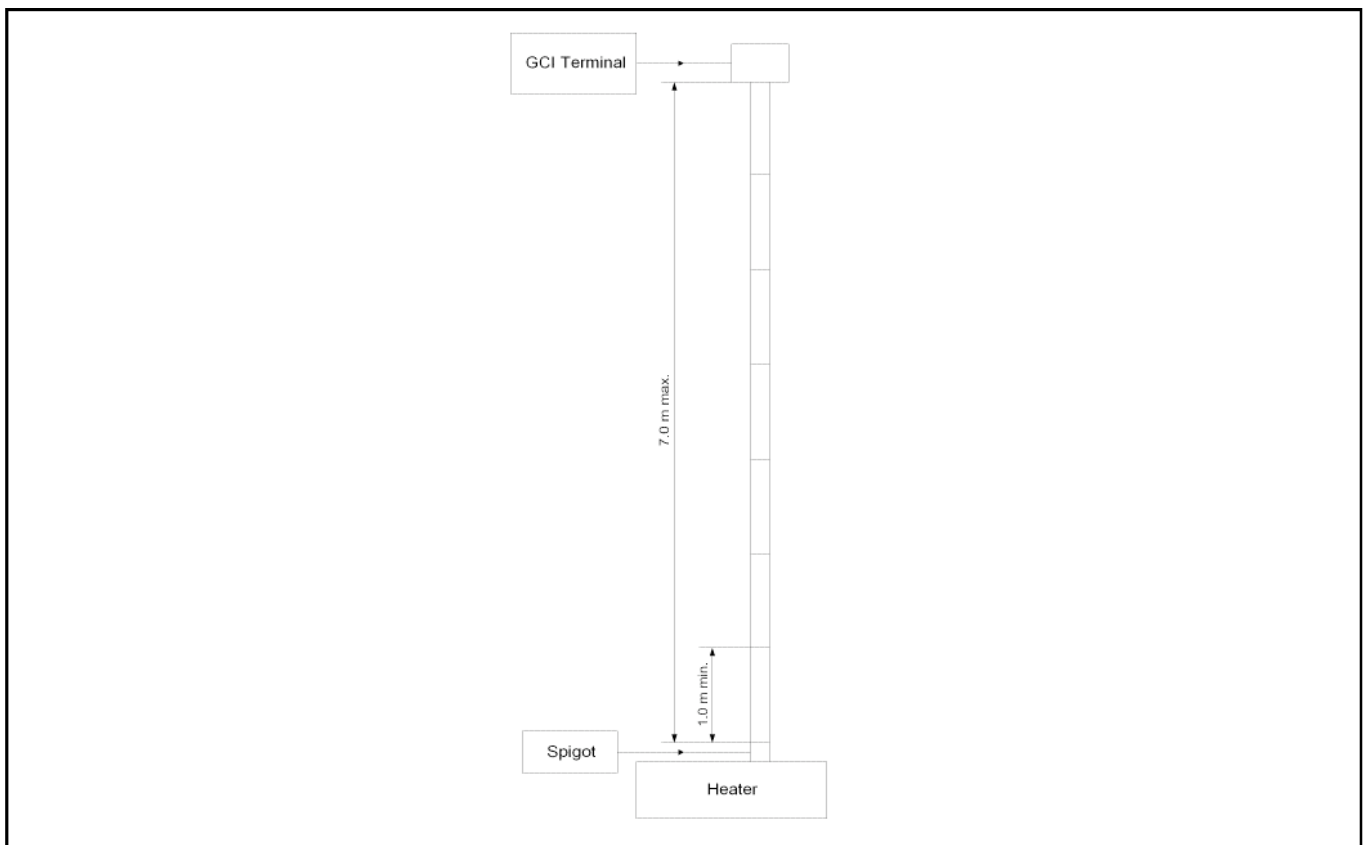

19 User instructions for Ambi-Rad Cobra series of heaters

Cobra is an overhead radiant heating system for industrial and commercial buildings. The Cobra heater is suspended horizontally overhead from the roof or inclined mounted at 30° to 45° from the horizontal and heats by radiation in the same way as the sun.

Important Information

1. This appliance must only be installed by a competent person in accordance with the requirements of the Codes of Practice or the rules in force in the country of use.
2. Warning this appliance must be earthed.
3. Never rest anything, especially ladders, against the heater.

To start the Cobra heater

1. First ensure that the gas supply to the heater is turned on.
2. Ensure that the settings of any time-switch and thermostat are such that the heating system will be required to operate.
3. Switch on electrical supply to heater. Mains light, coloured red will illuminate and ignition sequence will commence.
4. After completion of an air purge period, ignition of the burner will occur and burner light, amber, will illuminate.
5. If lock out occurs, switch off electrical supply, wait 15 seconds then switch on again. If lock out occurs again switch off heater and call out a service engineer.

Note 'U' bend will glow, but this is acceptable.

To switch off Cobra heater

1. Switch off electrical supply to the heater. The burner will shut off and the fan will stop.
2. If the heater is switched off for periods in excess of one week, it is highly recommended that both gas and electrical supplies are turned off.

Servicing

To ensure continued efficient and safe operation it is recommended that the heater is serviced regularly by a competent person e.g. every year in normal working conditions but in exceptionally dust or polluted conditions more frequent servicing may be required. The manufacturer, whose address is given below, offers a maintenance service. Details available on request.

The data plate (supplied) should be attached on, or adjacent to a low level user control, as it contains the instructions for the safe operation of the appliance including its lighting and shut-down procedures.



Ambi-Rad Limited Fens Pool Avenue
Brierley Hill West Midlands
DY5 1QA United Kingdom

Telephone 01384 489700
Facsimile 01384 489707
UK sales email sales@ambirad.co.uk
Website www.ambirad.co.uk

AMBIRAD is the registered
trademark of Ambi-Rad Limited.

Due to continuous product
innovation, Ambi-Rad reserves
the right to change product
specification without due notice.

Document reference number : GB/COB(40)/119/0205

AMBIRAD
ENERGY EFFICIENT HEATING SYSTEMS



An Ambi-Rad Group company