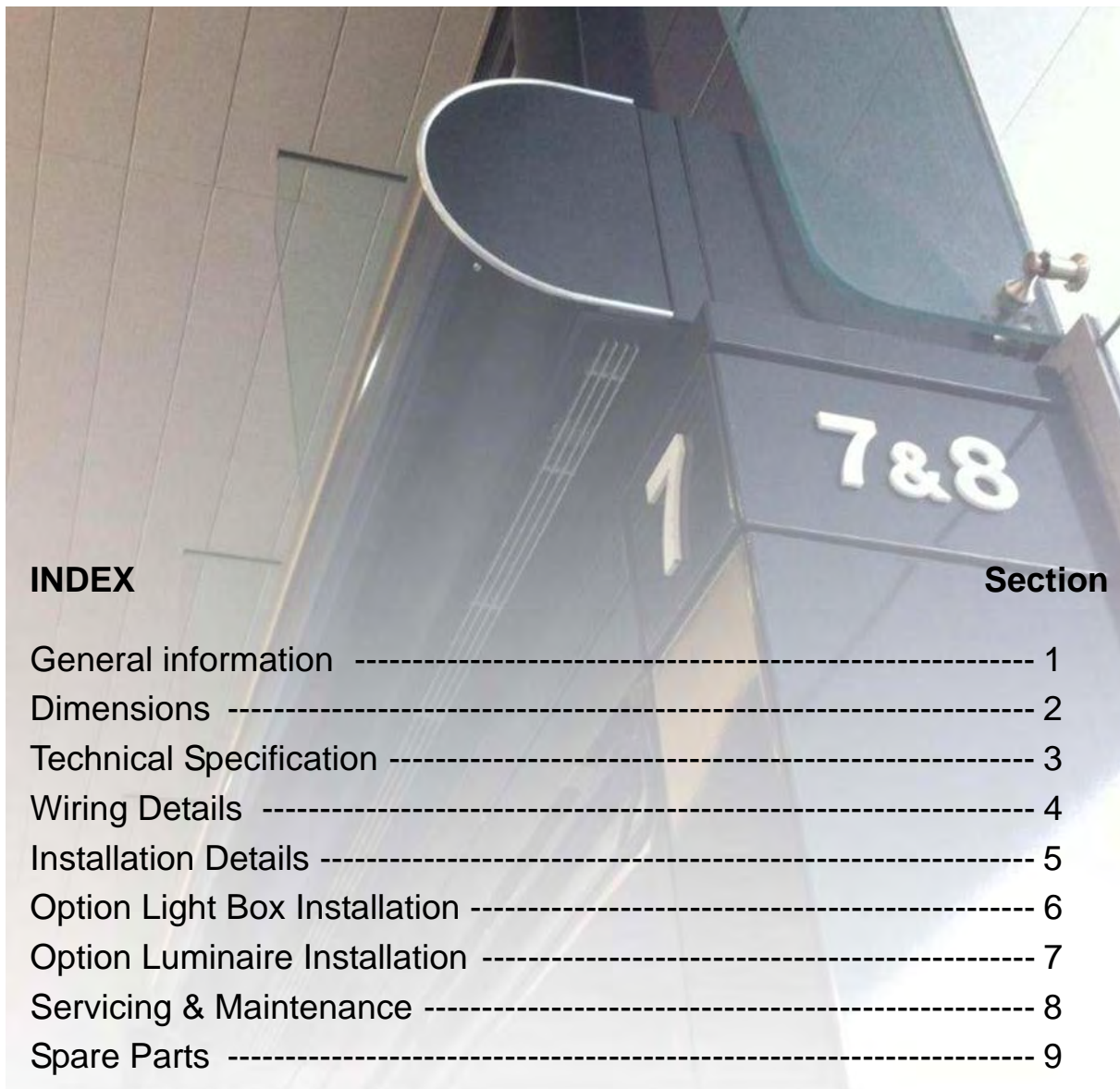


# AC COMMERCIAL & RETAIL

## ELECTRICALLY HEATED, AMBIENT & LPHW

# INSTALLATION AND OPERATING MANUAL



## INDEX

## Section

General information -----	1
Dimensions -----	2
Technical Specification -----	3
Wiring Details -----	4
Installation Details -----	5
Option Light Box Installation -----	6
Option Luminaire Installation -----	7
Servicing & Maintenance -----	8
Spare Parts -----	9
Fault Finding -----	10
Parts replacement -----	11
User Instructions -----	12

## WARNINGS

1 This appliance must only be installed by a competent person in accordance with the requirements of the Codes of Practice or the rules in force.

2 All external wiring MUST comply with the current IEE wiring regulations.

3 Warning this appliance must be earthed.



# Document Index.

## 1 Installation Requirements

- 1.1 Introduction
- 1.2 General
- 1.3 Electrical Supply
  - 1.3.1 Electronic Controller
  - 1.3.2 SmartElec2 Controller
- 1.4 Location
- 1.5 Clearance Distance
- 1.6 Health and Safety
- 1.7 Standards

## 2 Dimensions

- 2.1 AC Air Curtain
- 2.2 AC Chassis Air Curtain
- 2.3 Electronic Controller
- 2.4 Optional SmartElec2 Controller

## 3 Technical Specifications

- 3.1 Electrical Heated, Std Capacity 6&9kW 1P
- 3.2 Electrical Heated, Std Capacity 9-18kW
- 3.3 Electrical Heated, High Capacity 12-24kW
- 3.4 Ambient, Std Capacity
- 3.5 Ambient, High Capacity
- 3.6 LPHW, Std Capacity
- 3.7 LPHW, High Capacity
- 3.8 Electronic Controller
- 3.9 SmartElec2 Controller

## 4 Wiring Diagrams

- 4.1 Installer Wiring Electrically Heated 6&9kW 1P
- 4.2 Installer Wiring Electrically Heated 9&12kW
- 4.3 Installer Wiring Electrically Heated 18&24kW
- 4.4 Installer Wiring Ambient
- 4.5 Installer Wiring LPHW
- 4.6 Factory Wiring Electrically Heated 6&9kW 1P
- 4.7 Factory Wiring Electrically Heated 9&12kW
- 4.8 Factory Wiring Electrically Heated 18&24kW
- 4.9 Factory Wiring Ambient
- 4.10 Factory Wiring LPHW
- 4.11 Network Wiring Electronic Controller
- 4.12 Installer Wiring SmartElec2 Controller
- 4.13 Factory Wiring SmartElec2 Controller
- 4.14 Network Wiring SmartElec2 Controller

## 5 Installation Requirements

- 5.1 Mounting
- 5.2 Electrical Supply
- 5.3 Installation
- 5.4 Standard Controller
- 5.5 Option SmartElec2 Controller
- 5.6 LPHW only
  - 5.6.1 3 Port Valve
- 5.7 Wiring

## 6 Optional Light Box/Down Lighters

- 6.1 Dimensions
- 6.2 Installation
- 6.3 Wiring
- 6.4 Rear Panel & Sign Options

## 7 Optional Fire Exit Luminaries

- 7.1 General
- 7.2 Remote Switching
- 7.3 Commissioning/Testing
- 7.4 Specification
  - 7.4.1 Non-maintained
  - 7.4.2 Maintained
- 7.5 Installation
- 7.6 Wiring Diagram

## 8 Servicing & Maintenance Instructions

## 9 Spare Parts

- 9.1 General
- 9.2 AC-ACR-PANEL Controller
- 9.3 SmartElec2 Controller
- 9.4 Heating mediums

## 10 Fault Finding Guide

- 10.1 General
- 10.2 Electrical Heated
- 10.3 Electronic Controller
- 10.4 Optional SmartElec2Controller
  - 10.4.1 Fault Code chart
  - 10.4.2 LED indication

## 11 Replacing Parts

- 11.1 Rotor and Motor
- 11.2 Electrical Element
- 11.3 LPHW Coil

## 12 User and Operating Instructions

### 12.1 Standard Keypad

- 12.1.1 Keypad Buttons
- 12.1.2 Operation
- 12.1.3 Engineers Settings
  - 12.1.3.1 Auto Mode
  - 12.1.3.2 Door Switch Mode

### 12.2 Optional SmartElec2 Controller

- 12.2.1 Keypad Buttons
- 12.2.2 Keypad Display
  - 12.2.2.1 Normal Mode Display
  - 12.2.2.2 Normal Operation
- 12.2.3 Off Mode
- 12.2.4 Settings Mode
  - 12.2.4.1 Activate Settings Display
  - 12.2.4.2 Settings Display
- 12.2.5 Set Up Configuration
  - 12.2.5.1 Set Fan Speed
  - 12.2.5.2 Set Heat
  - 12.2.5.3 Set Temperature
  - 12.2.5.4 Networked Air Curtains
- 12.2.6 Engineers Settings
  - 12.2.6.1 Door Link Settings
  - 12.2.6.2 Link-group Interlock
  - 12.2.6.3 All Air Curtains
  - 12.2.6.4 External Temperature
  - 12.2.6.5 External Temperature Offset
  - 12.2.6.6 Temperature Limits
- 12.2.7 Power-up Manual Reset
- 12.2.8 Air Curtain Addressing
- 12.2.9 Keypad Sequences

# General Information

## 1.1 Introduction

This instruction manual describes the Airbloc AC Commercial & Retail range of air curtains.

Models range from 1000mm to 2000mm in length, in both Standard and High capacity and are available in either Electrically Heated, Ambient or LPHW. They are designed for mounting above or slung on drop rods above doorways.

Each air curtain is supplied with a fully electronic controller giving multi fan and heat settings (electrically operated units) via a simple key pad which can be mounted up to 50m from the air curtain. Optional BMS time control, external thermostats and door interlocks can be installed.



**fig.1. AC-ACR-PANEL program keypad**

The **AC-ACR-PANEL programmer** shown above allows the user to control either a single air curtain, or a network of up to 6 air curtains with the same settings, and provides the following functions:-

- Heat On Off or Auto via optional thermostat
  - Off or Low, Medium and High Fan Speeds
- For further details please refer to section 12.2

Alternatively on electrically heated models, an optional SmartElec2 control system consists of a base unit (installed within the air curtain) and a program panel that can be installed remote from the air curtain. Usually, the program panel is mounted at a low level from the air curtain for user access and to a maximum distance of 50m. The base unit and program panel are linked by low voltage cable as specified in these instructions.

The **SmartElec2 factory fitted base unit** provides terminals for 3 phase supply connection and the low voltage program panel wires. The SmartElec2 base unit rapidly pulses energy to the heating elements. This combined with the inbuilt intelligent sensor control, maintains a fixed outlet temperature, thereby reducing energy consumption as compared to an air curtain without the SmartElec2 control.



**fig.2. SmartElec2 Controller**

The **SmartElec2 program panel** shown above allows the user to control either a single air curtain, or a network of up to 16 air curtains, each with different settings if required, and provides the following functions:-

- Heat On or Off
- Off or Low, Medium and High Fan Speeds
- Air Outlet Temperature.

For further details please refer to section 12.4

## 1.2 General

All installations must be in accordance with the regulations in force in the country of use.

These instructions must be handed to the user on completion of the installation.

Installers and service engineers must be able to demonstrate competence and be suitably qualified in accordance with the regulations in force in the country of use.

To ensure continued and safe operation it is recommended that the appliance is serviced annually.

The manufacturer, offers a maintenance service. Details are available on request.

The air curtain outlet grille and case air inlet slots must not be obstructed during use.

## 1.3 Electrical Supply

For full electrical loadings, please refer to the individual technical data sheets within this manual.

It is recommended that the electrical supply to the base unit in the air curtain is via an appropriate switched isolator in accordance with the regulations in force in the country of use and must be via a fused isolator having a contact separation of greater than 3mm in all poles.

BMS control, time switches, room thermostats and door interlocks can be installed at the discretion and responsibility of the installer.

All units must be wired in accordance with I.E.E regulations for the Electrical Equipment of Buildings and the installer should ensure that a suitable isolating switch is connected in the mains supply.

### **Warning**

For safety reasons a good earth connection must ALWAYS be made to the heater and control box.

#### **1.3.1 Electronic controller**

Electrically heated supply is either 230V 1 phase (6 and 9kW options) or 415V 3 phase (9 to 24kW), Neutral and Earth. Max cable inlet size is 4mm<sup>2</sup> or 6mm<sup>2</sup> (refer to individual technical specification)

Ambient and LPHW supply is 230V 1 phase, Neutral and Earth. Max cable inlet size is 4mm<sup>2</sup>.

Remote unit is wired to the base unit via a Screened twisted pair 28AWG (or direct equiv).

#### **1.3.2 SmartElec2 controller**

Electrically heated supply is 415V 3 phase, neutral and earth. Max cable inlet size is 10mm<sup>2</sup>.

Remote unit is wired to the base unit via a 4 core pre-wired cable.

Networked air curtain interconnects via a 4 core pre-wired cable.

## **1.4 Location**

Airbloc units should be installed horizontally directly over the door opening. It is recommended that the air curtain is installed on the inside of the building, within the open room space against a wall or ceiling. AC chassis units are designed to be positioned in suspended ceilings or bulkheads.

Care must be taken to allow complete free air movement into the inlet grilles of the unit to ensure correct working operation of the air curtain. The discharge opening should be as close to the top of the door as possible and to cover the entire door width.

Units can be mounted adjacent to each other to cover the full door opening across wider entrances.

These units are designed for surface mounting and should not be placed into a ceiling void, due to possible obstruction of airflow and difficulty in routine cleaning and maintenance.

## **1.5 Clearance distances**

It is recommended that a minimum clearance of 300mm is allowed around the top and front of the unit. The clearance allows for cable entry and prevents combustible surfaces overheating.

The minimum mounting height (floor to grille outlet) is 1.8m. The recommended maximum mounting height is 3m for standard and 4m for high capacity models.

## **1.6 Health and Safety.**

Sole liability rests with the installer to ensure that all site safety procedures are adhered to during installation.

Sole liability rests with the installer to ensure that protective safety wear such as hand, eye, ear and head protection is used during installation of the product.

Do not rest anything especially ladders against the product.

## **1.7 Standards**

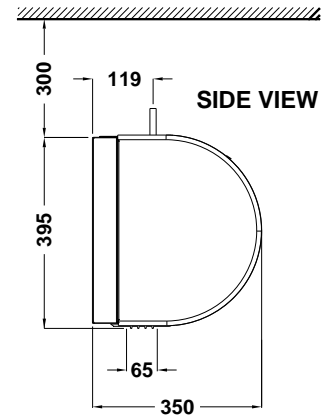
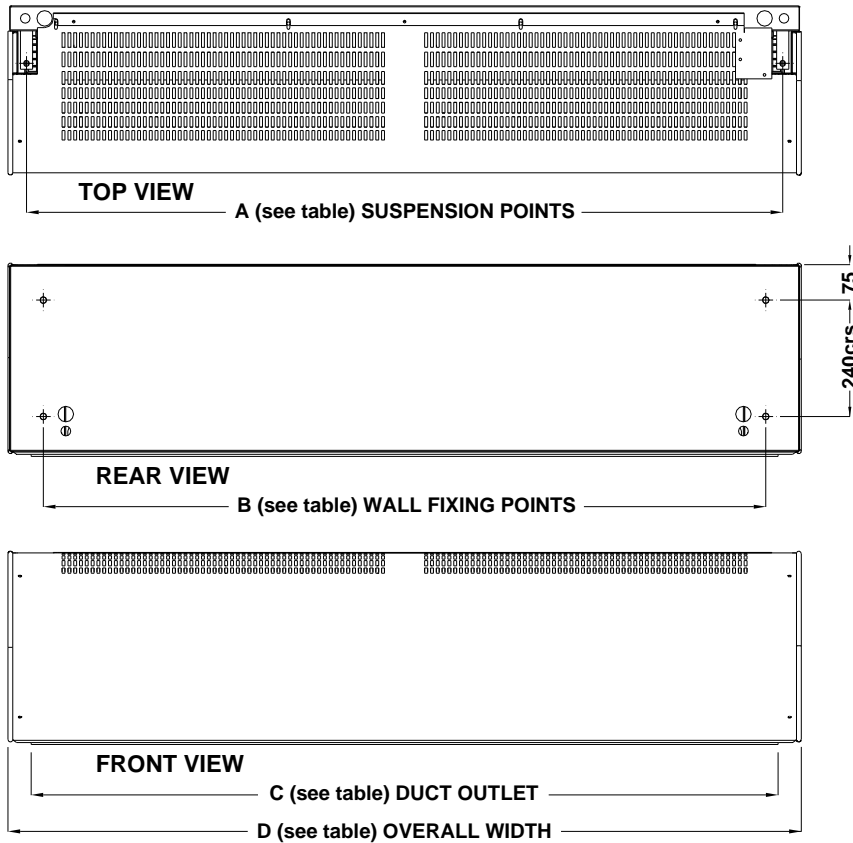
Units conform to the European electrical standard BS EN 60335-2-30 and to the following European CE directives-

2006/95/EC - low voltage;

2004/108/EC - electromagnetic compatibility.

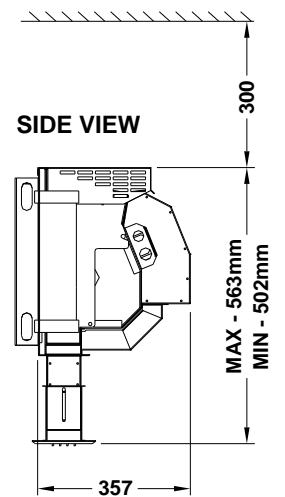
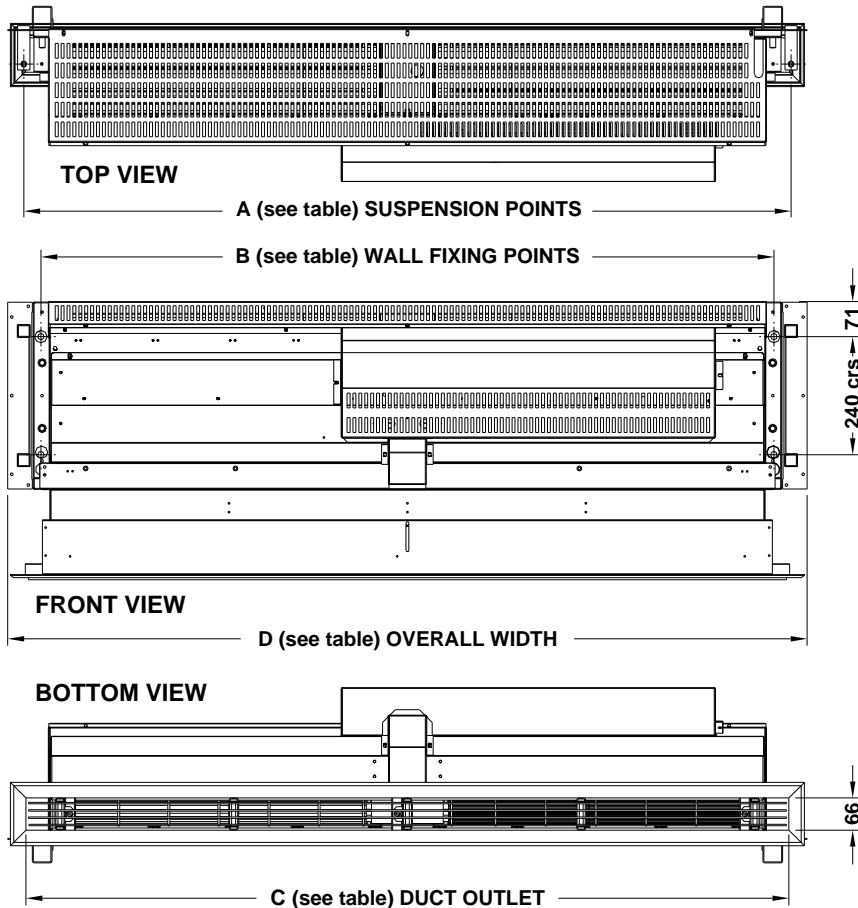
## 2. Dimensions.

### 2.1 AC Air Curtain



mm	1000	1500	2000
A	1062	1562	2062
B	992	1492	1992
C	1053	1553	2053
D	1138	1638	2138

### 2.2 AC Chassis Air Curtain



mm	1000	1500	2000
A	1062	1562	2062
B	992	1492	1992
C	1053	1553	2053
D	1138	1638	2138

### 2.3 AC-ACR-PANEL program keypad

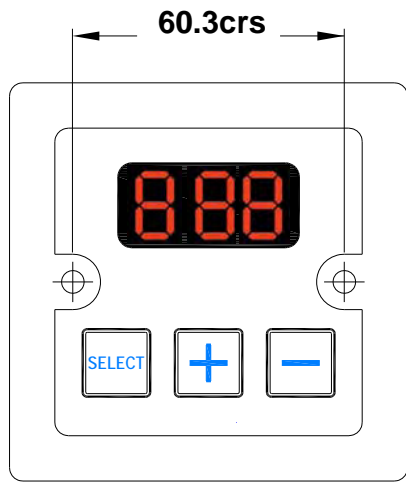


Fig.3. Surface mount

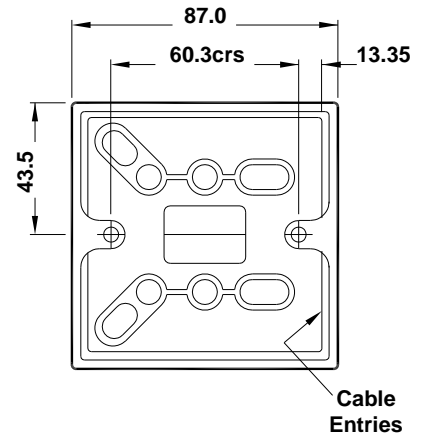
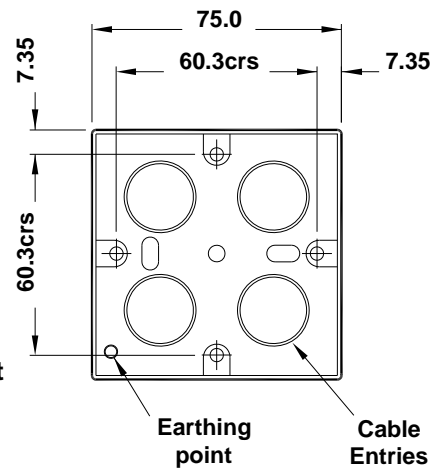
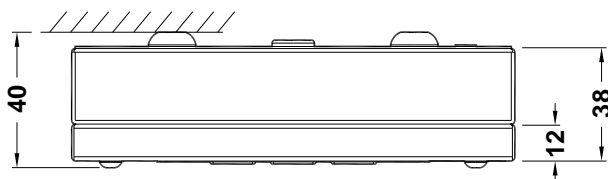
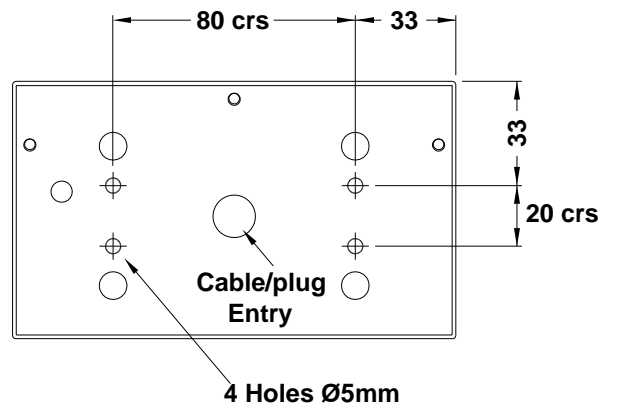
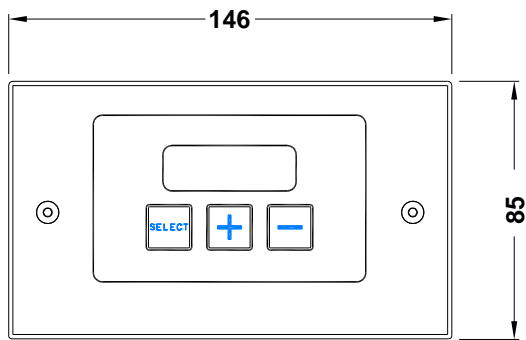


Fig.4. optional flush mount



### 2.4 Optional SmartElec2 Controller dimensions



### 3. Technical Specification.

3.1 (Single Phase only)			AC1000SE6-1PH	AC1500SE6-1PH	AC2000SE9-1PH
<b>General Data</b>					
Maximum height	M		3.0		
Door width	M		1.0	1.5	2.0
Heat medium			Electric heated		
Heat settings	kW		3 / 6		4.5 / 9
Fan type / dia			Crossflow / 150mm		
Fan settings			3		
Switching type			AC-ACR-PANEL / SmartElec		
Weight	kg		39.5	49.0	60.0
<b>Electrical Data</b>					
Supply voltage			230V 1ph 50Hz		
Total load	kW		6.4		9.4
	amps		27.7		40.7
Motor power	W		370		
Max Starting current*	amps		5.0		
Max Running current*	amps		2.1		
External fuse size amps	amps		32		45
Programmer keypad	pt. no.		AC-ACR-PANEL		
Program keypad control wiring			Screened twisted pair 28AWG		
Cable terminal size			6.0mm <sup>2</sup> Max		
Mains terminal block position			Separate din rail L1; N & E		
Control terminal block position			Right side of base unit terminals +12V, DATA & GND		
<b>Air Data</b>					
Air volume	<i>Low speed</i>	m <sup>3</sup> /h	1300	1600	2900
	<i>Medium speed</i>	m <sup>3</sup> /h	1850	2400	4100
	<i>High speed</i>	m <sup>3</sup> /h	2300	3300	5000
Air velocity	<i>Low @ 0M</i>	m/s	6.0		
	<i>Medium @ 0M</i>	m/s	8.5		
	<i>High @ 0M</i>	m/s	11.0		
	<i>High @ 1M</i>	m/s	5.4	5.5	5.2
	<i>High @ 2M</i>	m/s	3.6	3.7	3.6
	<i>High @ 3M</i>	m/s	2.6	2.5	2.4
	Delta T	<i>Low speed</i>	°C	20	13
<i>Medium speed</i>		°C	13	9	10
<i>High speed</i>		°C	11	7	7
Noise level @ 3M in free field	<i>Low speed</i>	dBA	50		
	<i>Medium speed</i>	dBA	55		
	<i>High speed</i>	dBA	60		
<b>Dims Data</b>					
Length	mm		1138	1638	2138
Depth (width)	mm		350		
Height including outlet	mm		395 ( Chassis - min 502 max 563)		
Outlet length	mm		1095	1595	2095
Outlet depth	mm		65		
Outlet height	mm		Flush ( Chassis - min 107 max 168)		
Drop rod mounting rear to centres on depth	mm		119		
Drop rod side to 1st Centre	mm		38		
Drop rod mounting centres on length	mm		1062	1562	2062
Wall mounting side to 1st centre	mm		73		
Wall mounting top to 1st centre	mm		75		
Wall mounting centres on length	mm		992	1492	1992
Wall mounting centres on height	mm		240		

\* Motor current only at high speed

3.2			AC1000SE9	AC1500SE12	AC2000SE18
<b>General Data</b>					
Maximum height	M		3.0		
Door width	M	1.0	1.5	2.0	
Heat medium		Electric heated			
Heat setting	kW	4.5 / 9	6 / 12	9 / 18	
Fan type / dia		Crossflow / 150mm			
Fan settings		3			
Switching type		AC-ACR-PANEL / SmartElec2			
Weight	kg	39.5	49.0	60.0	
<b>Electrical Data</b>					
Supply voltage		415V 3ph 50Hz			
Total load	kW	9.4	12.4	18.4	
	A/pha	13.1	17.3	25.6	
Motor power	W	370			
Max Starting current*	amps	5.0			
Max Running current*	amps	2.1			
External fuse size amps	A/pha	16	20	32	
Programmer keypad	pt. no.	AC-ACR-PANEL			
Program keypad control wiring		Screened twisted pair 28AWG			
Cable terminal size		4.0mm <sup>2</sup> Max		6.0mm <sup>2</sup> Max	
Mains terminal block position		Bottom of base unit. Terminals N; L1; L2 & L3		Separate din rail E: N; L1; L2 & L3	
Control terminal block position		Right side of base unit terminals +12V, DATA & GND			
** SmartElec2 Energy Saving Control	pt. no.	SELEC2BU			
SmartElec2 Energy Saving Control wiring		4 core pre-wired RS485 plugs			
Cable terminal size		10.0mm <sup>2</sup> Max			
Mains terminal block position		SmartElec2 Base Unit - terminals N; L1; L2 & L3			
Control cable socket position		SmartElec2 Base Unit			
<b>Air Data</b>					
Air volume	Low speed	m <sup>3</sup> /h	1300	1600	2900
	Medium speed	m <sup>3</sup> /h	1850	2400	4100
	High speed	m <sup>3</sup> /h	2300	3300	5000
Air velocity	Low @ 0M	m/s	6.0		
	Medium @ 0M	m/s	8.5		
	High @ 0M	m/s	11.0		
	High @ 1M	m/s	5.4	5.5	5.2
	High @ 2M	m/s	3.6	3.7	3.6
	High @ 3M	m/s	2.6	2.5	2.4
	Delta T	Low speed	°C	30	26
Medium speed		°C	22	18	19
High speed		°C	17	15	15
Noise level @ 3M in free field	Low speed	dBA	50		
	Medium speed	dBA	55		
	High speed	dBA	60		
<b>Dims Data</b>					
Length	mm	1138	1638	2138	
Depth (width)	mm	350			
Height including outlet	mm	395 ( Chassis - min 502 max 563)			
Outlet length	mm	1095	1595	2095	
Outlet depth	mm	65			
Outlet height	mm	Flush ( Chassis - min 107 max 168)			
Drop rod mounting rear to centres on depth	mm	119			
Drop rod side to 1st Centre	mm	38			
Drop rod mounting centres on length	mm	1062	1562	2062	
Wall mounting side to 1st centre	mm	73			
Wall mounting top to 1st centre	mm	75			
Wall mounting centres on length	mm	992	1492	1992	
Wall mounting centres on height	mm	8	240		

\* Motor current only at high speed

\*\*Suffix with -SM for SmartElec2 Energy Saving Control.

3.3			AC1000HE12	AC1500HE18	AC2000HE24
<b>General Data</b>					
Maximum height		M	4.0		
Door width		M	1.0	1.5	2.0
Heat medium			Electric heated		
Heat setting		kW	6 / 12	9 / 18	12 / 24
Fan type / dia			Crossflow / 150mm		
Fan settings			3		
Switching type			AC-ACR-PANEL / SmartElec2		
Weight		kg	39.5	49.0	60.0
<b>Electrical Data</b>					
Supply voltage			415V 3ph 50Hz		
Total load		kW	12.4	18.4	24.4
		A/pha	17.3	25.6	34.0
Motor power		W	370		
Max Starting current*		amps	5.0		
Max Running current*		amps	2.1		
External fuse size amps		A/pha	20	32	40
Programmer keypad		pt. no.	AC-ACR-PANEL		
Program keypad control wiring			Screened twisted pair 28AWG		
Cable terminal size			4.0mm <sup>2</sup> Max	6.0mm <sup>2</sup> Max	
Mains terminal block position			Base unit N; L1; L2 & L3	Separate din rail E; N; L1; L2 & L3	
Control terminal block position			Right side of base unit terminals +12V, DATA & GND		
** SmartElec2 Energy Saving Control		pt. no.	SELEC2BU		
SmartElec2 Energy Saving Control wiring			4 core pre-wired RS485 plugs		
Cable terminal size			10.0mm <sup>2</sup> Max		
Mains terminal block position			SmartElec2 Base Unit - terminals N; L1; L2 & L3		
Control cable socket position			SmartElec2 Base Unit		
<b>Air Data</b>					
Air volume	<i>Low speed</i>	m <sup>3</sup> /h	1300	1600	2900
	<i>Medium speed</i>	m <sup>3</sup> /h	1850	2400	4100
	<i>High speed</i>	m <sup>3</sup> /h	2300	3300	5000
Air velocity	<i>Low @ 0M</i>	m/s	6.0		
	<i>Medium @ 0M</i>	m/s	8.5		
	<i>High @ 0M</i>	m/s	11.0		
	<i>High @ 1M</i>	m/s	5.4	5.5	5.2
	<i>High @ 2M</i>	m/s	3.6	3.7	3.6
	<i>High @ 3M</i>	m/s	2.6	2.5	2.4
	<i>High @ 4M</i>	m/s	1.5	1.6	1.4
Delta T	<i>Low speed</i>	°C	35	35	36
	<i>Medium speed</i>	°C	28	27	26
	<i>High speed</i>	°C	22	22	20
Noise level @ 3M <i>in free field</i>	<i>Low speed</i>	dBA	50		
	<i>Medium speed</i>	dBA	55		
	<i>High speed</i>	dBA	60		
<b>Dims Data</b>					
Length		mm	1138	1638	2138
Depth (width)		mm	350		
Height including outlet		mm	395 ( Chassis - min 502 max 563)		
Outlet length		mm	1095	1595	2095
Outlet depth		mm	65		
Outlet height		mm	Flush ( Chassis - min 107 max 168)		
Drop rod mounting rear to centres on depth		mm	119		
Drop rod side to 1st Centre		mm	38		
Drop rod mounting centres on length		mm	1062	1562	2062
Wall mounting side to 1st centre		mm	73		
Wall mounting top to 1st centre		mm	75		
Wall mounting centres on length		mm	992	1492	1992
Wall mounting centres on height		mm	9	240	

\* Motor current only at high speed

\*\*Suffix with -SM for SmartElec2 Energy Saving Control.

3.4			AC1000SA	AC1500SA	AC2000SA
<b>General Data</b>					
Maximum height	M		3.0		
Door width	M	1.0	1.5	2.0	
Heat medium		Ambient			
Fan type / dia		Crossflow / 150mm			
Fan settings		3			
Switching type		AC-ACR-PANEL			
Weight	kg	39.5	49.0	60.0	
<b>Electrical Data</b>					
Supply voltage		230V 1ph 50Hz			
Total load	kW	0.4			
	amps	1.61			
Motor power	W	370			
Max Starting current*	amps	5.0			
Max Running current*	amps	2.1			
External fuse size amps	amps	10			
Programmer keypad	pt. no.	AC-ACR-PANEL			
Program keypad control wiring		Screened twisted pair 28AWG			
Cable terminal size		4.0mm <sup>2</sup> Max			
Mains terminal block position		Base unit L1; N + E			
Control terminal block position		Right side of base unit terminals +12V, DATA & GND			
<b>Air Data</b>					
Air volume	<i>Low speed</i>	m <sup>3</sup> /h	1300	1600	2900
	<i>Medium speed</i>	m <sup>3</sup> /h	1850	2400	4100
	<i>High speed</i>	m <sup>3</sup> /h	2300	3300	5000
Air velocity	<i>Low @ 0M</i>	m/s	6.0		
	<i>Medium @ 0M</i>	m/s	8.5		
	<i>High @ 0M</i>	m/s	11.0		
	<i>High @ 1M</i>	m/s	5.4	5.5	5.2
	<i>High @ 2M</i>	m/s	3.6	3.7	3.6
	<i>High @ 3M</i>	m/s	2.6	2.5	2.4
Noise level @ 3M in free field	<i>Low speed</i>	dBA	50		
	<i>Medium speed</i>	dBA	55		
	<i>High speed</i>	dBA	60		
<b>Dims Data</b>					
Length	mm	1138	1638	2138	
Depth (width)	mm	350			
Height including outlet	mm	395 ( Chassis - min 502 max 563)			
Outlet length	mm	1095	1595	2095	
Outlet depth	mm	65			
Outlet height	mm	Flush ( Chassis - min 107 max 168)			
Drop rod mounting rear to centres on depth	mm	119			
Drop rod side to 1st Centre	mm	38			
Drop rod mounting centres on length	mm	1062	1562	2062	
Wall mounting side to 1st centre	mm	73			
Wall mounting top to 1st centre	mm	75			
Wall mounting centres on length	mm	992	1492	1992	
Wall mounting centres on height	mm	240			

\* Motor current only at high speed

3.5			AC1000HA	AC1500HA	AC2000HA
<b>General Data</b>					
Maximum height	M		4.0		
Door width	M	1.0	1.5	2.0	
Heat medium		Ambient			
Fan type / dia		Crossflow / 150mm			
Fan settings		3			
Switching type		AC-ACR-PANEL			
Weight	kg	39.5	49.0	60.0	
<b>Electrical Data</b>					
Supply voltage		230V 1ph 50Hz			
Total load	kW	0.4			
	amps	1.6			
Motor power	W	370			
Max Starting current*	amps	5.0			
Max Running current*	amps	2.1			
External fuse size amps	amps	10			
Programmer keypad	pt. no.	AC-ACR-PANEL			
Program keypad control wiring		Screened twisted pair 28AWG			
Cable terminal size		4.0mm <sup>2</sup> Max			
Mains terminal block position		Base unit L1; N + E			
Control terminal block position		Right side of base unit terminals +12V, DATA & GND			
<b>Air Data</b>					
Air volume	<i>Low speed</i>	m <sup>3</sup> /h	1300	1600	2900
	<i>Medium speed</i>	m <sup>3</sup> /h	1850	2400	4100
	<i>High speed</i>	m <sup>3</sup> /h	2300	3300	5000
Air velocity	<i>Low @ 0M</i>	m/s	6.0		
	<i>Medium @ 0M</i>	m/s	8.5		
	<i>High @ 0M</i>	m/s	11.0		
	<i>High @ 1M</i>	m/s	5.4	5.5	5.2
	<i>High @ 2M</i>	m/s	3.6	3.7	3.6
	<i>High @ 3M</i>	m/s	2.6	2.5	2.4
	Noise level @ 3M <i>in free field</i>	<i>Low speed</i>	dBA	50	
<i>Medium speed</i>		dBA	55		
<i>High speed</i>		dBA	60		
<b>Dims Data</b>					
Length	mm	1138	1638	2138	
Depth (width)	mm	350			
Height including outlet	mm	395 ( Chassis - min 502 max 563)			
Outlet length	mm	1095	1595	2095	
Outlet depth	mm	65			
Outlet height	mm	Flush ( Chassis - min 107 max 168)			
Drop rod mounting rear to centres on depth	mm	119			
Drop rod side to 1st Centre	mm	38			
Drop rod mounting centres on length	mm	1062	1562	2062	
Wall mounting side to 1st centre	mm	73			
Wall mounting top to 1st centre	mm	75			
Wall mounting centres on length	mm	992	1492	1992	
Wall mounting centres on height	mm	240			

\* Motor current only at high speed

3.6			AC1000SW9	AC1500SW12	AC2000SW18
<b>General Data</b>					
Maximum height	M			3.0	
Door width	M		1.0	1.5	2.0
Heat medium			LPHW		
Heat setting	kW		9	12	18
Fan type / dia			Crossflow / 150mm		
Fan settings			3		
Switching type			AC-ACR-PANEL		
Weight	kg		39.5	49.0	60.0
<b>Electrical Data</b>					
Supply voltage			230V 1ph 50Hz		
Total load	kW		0.4		
	amps		1.6		
Motor power	W		370		
Max Starting current*	amps		5.0		
Max Running current*	amps		2.1		
External fuse size amps	A/pha		10		
Programmer keypad	pt. no.		AC-ACR-PANEL		
Program keypad control wiring			Screened twisted pair 28AWG		
Cable terminal size			4.0mm <sup>2</sup> Max		
Mains terminal block position			Base unit L1; N + E		
Control terminal block position			Right side of base unit terminals +12V, DATA & GND		
<b>Air Data</b>					
Air volume	<i>Low speed</i>	m <sup>3</sup> /h	1300	1600	2900
	<i>Medium speed</i>	m <sup>3</sup> /h	1850	2400	4100
	<i>High speed</i>	m <sup>3</sup> /h	2300	3300	5000
Air velocity	<i>Low @ 0M</i>	m/s	6.0		
	<i>Medium @ 0M</i>	m/s	8.5		
	<i>High @ 0M</i>	m/s	11.0		
	<i>High @ 1M</i>	m/s	5.4	5.5	5.2
	<i>High @ 2M</i>	m/s	3.6	3.7	3.6
	<i>High @ 3M</i>	m/s	2.6	2.5	2.4
	Delta T	<i>Low speed</i>	°C	30	26
<i>Medium speed</i>		°C	22	18	19
<i>High speed</i>		°C	17	15	15
Noise level @ 3M in free field	<i>Low speed</i>	dBA	50		
	<i>Medium speed</i>	dBA	55		
	<i>High speed</i>	dBA	60		
<b>LPHW Data</b>					
LPHW flow	l/s		0.20	0.27	0.40
Fluid pressure drop	kPA		23.0	15.0	
Flow & return connection	mm		15		
Inlet temp	°C		82		
Outlet temp	°C		71		
<b>Dims Data</b>					
Length	mm		1138	1638	2138
Depth (width)	mm		350		
Height including outlet	mm		395 ( Chassis - min 502 max 563)		
Outlet length	mm		1095	1595	2095
Outlet depth	mm		65		
Outlet height	mm		Flush ( Chassis - min 107 max 168)		
Drop rod mounting rear to centres on depth	mm		119		
Drop rod side to 1st Centre	mm		38		
Drop rod mounting centres on length	mm		1062	1562	2062
Wall mounting side to 1st centre	mm		73		
Wall mounting top to 1st centre	mm		75		
Wall mounting centres on length	mm		992	1492	1992
Wall mounting centres on height	mm		240		

\* Motor current only at high speed

3.7			AC1000HW12	AC1500HW18	AC2000HW24
<b>General Data</b>					
Maximum height	M		4.0		
Door width	M	1.0	1.5	2.0	
Heat medium		LPHW			
Heat setting	kW	12	18	24	
Fan type / dia		Crossflow / 150mm			
Fan settings		3			
Switching type		AC-ACR-PANEL			
Weight	kg	39.5	49.0	60.0	
<b>Electrical Data</b>					
Supply voltage		230V 1ph 50Hz			
Total load	kW	0.4			
	amps	1.61			
Motor power	W	370			
Max Starting current*	amps	5.0			
Max Running current*	amps	2.1			
External fuse size amps	A/pha	10			
Programmer keypad	pt. no.	AC-ACR-PANEL			
Program keypad control wiring		Screened twisted pair 28AWG			
Cable terminal size		4.0mm <sup>2</sup> Max			
Mains terminal block position		Base unit L1; N + E			
Control terminal block position		Right side of base unit terminals +12V, DATA & GND			
<b>Air Data</b>					
Air volume	<i>Low speed</i>	m <sup>3</sup> /h	1300	1600	2900
	<i>Medium speed</i>	m <sup>3</sup> /h	1850	2400	4100
	<i>High speed</i>	m <sup>3</sup> /h	2300	3300	5000
Air velocity	<i>Low @ 0M</i>	m/s	6.0		
	<i>Medium @ 0M</i>	m/s	8.5		
	<i>High @ 0M</i>	m/s	11.0		
	<i>High @ 1M</i>	m/s	5.4	5.5	5.2
	<i>High @ 2M</i>	m/s	3.6	3.7	3.6
	<i>High @ 3M</i>	m/s	2.6	2.5	2.4
	<i>High @ 4M</i>	m/s	1.5	1.6	1.4
Delta T	<i>Low speed</i>	°C	35	35	36
	<i>Medium speed</i>	°C	28	27	26
	<i>High speed</i>	°C	22	22	20
Noise level @ 3M <i>in free field</i>	<i>Low speed</i>	dBA	50		
	<i>Medium speed</i>	dBA	55		
	<i>High speed</i>	dBA	60		
<b>LPHW Data</b>					
LPHW flow	l/s	0.27	0.40	0.53	
Fluid pressure drop	kPA	19	23	24	
Flow & return connection	mm	15			
Inlet temp	°C	82			
Outlet temp	°C	71			
<b>Dims Data</b>					
Length	mm	1138	1638	2138	
Depth (width)	mm	350			
Height including outlet	mm	395 ( Chassis - min 502 max 563)			
Outlet length	mm	1095	1595	2095	
Outlet depth	mm	65			
Outlet height	mm	Flush ( Chassis - min 107 max 168)			
Drop rod mounting rear to centres on depth	mm	119			
Drop rod side to 1st Centre	mm	38			
Drop rod mounting centres on length	mm	1062	1562	2062	
Wall mounting side to 1st centre	mm	73			
Wall mounting top to 1st centre	mm	75			
Wall mounting centres on length	mm	992	1492	1992	
Wall mounting centres on height	mm	240			

\* Motor current only at high speed

<b>3.8</b>		<b>Program Controller</b>
<b>General Data</b>		
Sensor input	NTC	
Protection	2 x 'slow blow' fuse for the protection of the heater switching devices.	
Fan Output	3 off Relay for High, Medium and Low Fan setting 3A max 240Vac	
Connections	Screw terminals 4 for supply, 6 for heater output, 4 for fan output, 2 for BMS (time) control, 2 for sensor input, 2 for external thermal trip, 2 for external door switch .	
Supply	230V 1Ph or 415 3Ph dependent on model type.	
Dimensions	Program panel 88mm(L) x 88mm(W) max.	
Mounting positions	Program panel fixing centres 60.3mm	
Temperature	5 to 50 °C operating; -20 to 65 °C storage	
Display	Three 7-segment LCD red for parameter display	
Push buttons	3 positive feedback tactile push buttons	

<b>3.9</b>		<b>SmartElec2 Controller</b>
<b>General Data</b>		
Sensor input	NTC	
Control Setpoint	16 to 35 °C in steps of 1 degree	
Temperature Control	Proportional with 1°C hysteresis	
Minimum Power	0% to 99 %	
Cycle time	2 seconds fixed	
Protection	2 x high speed fuse for the protection of the heater switching devices	
Fan Output	3 off Relay for High, Medium and Low Fan setting 3A max 240Vac	
Connections	Screw terminals 5 for supply, 3 for heater output, 4 for fan output, 2 for BMS (time) control, 2 for sensor input, 2 for external thermal trip, 2 for external sensor, 2 for door, 2 for cooling fan on 24kW models. RS485 comms connection to base unit via pre-wired cable.	
Supply	415 V rms +/-15% 50/60Hz 5VA max.	
Dimensions	Program panel 146mm(L) x 85mm(W) x 38mm(D) max.	
Mounting positions	Program panel fixing centres 80mm x 20mm	
Temperature	5 to 50 °C operating; -20 to 65 °C storage	
Display	Three 7-segment LCD red for parameter display	
Push buttons	3 positive feedback tactile push buttons	

# 4. Wiring Diagrams.

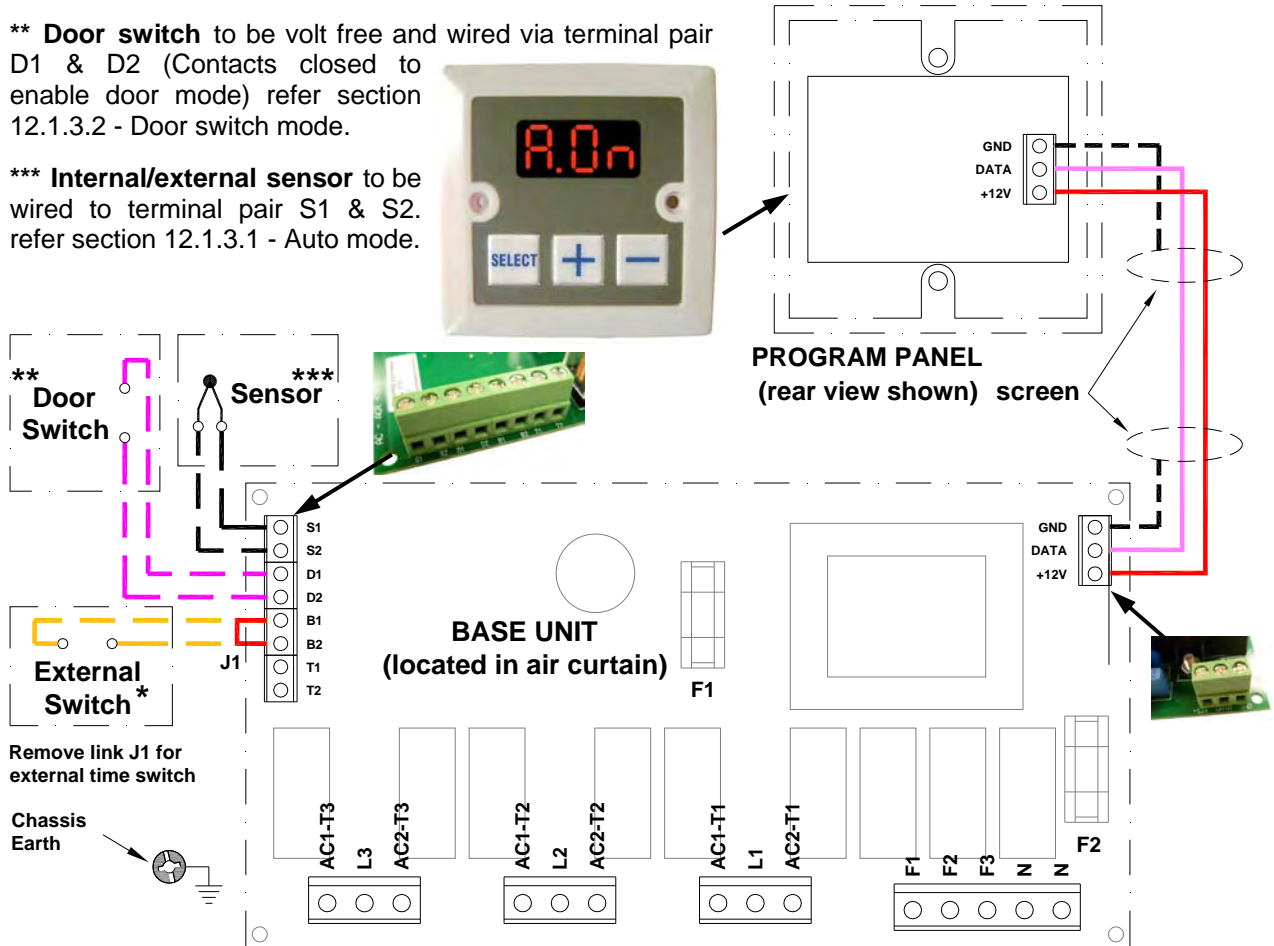
## 4.1 Installer Wiring - Electrically Heated 6 & 9kW SINGLE PHASE ONLY

The program panel is connected to the base unit via a set of 3 way connectors marked "+12V", "DATA" and "GND". Interconnecting wiring is via screened twisted pair 28AWG as shown. **Max length 50m.** It is recommended that this cable is run separately within its own trunking to avoid external interference.

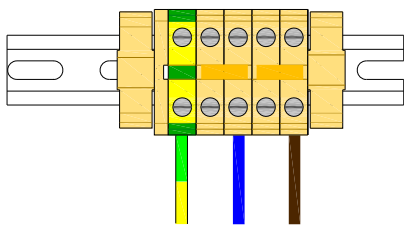
\* **External switch** (ie BMS enable) to be volt free and wired via normally open contacts to terminal pair B1, B2. (Contacts closed to enable). Remove factory fitted jumper J1.

\*\* **Door switch** to be volt free and wired via terminal pair D1 & D2 (Contacts closed to enable door mode) refer section 12.1.3.2 - Door switch mode.

\*\*\* **Internal/external sensor** to be wired to terminal pair S1 & S2. refer section 12.1.3.1 - Auto mode.



### Contractors Terminal



**230V 50Hz  
Mains Supply**

### Protection

External circuit breaker with the appropriate rating should be installed for the protection of the installation.

Terminal	Description	Cable
N	Neutral	6mm <sup>2</sup> max
L1	1 phase supply	6mm <sup>2</sup> max
Pcb Terminal		Cable 1.0mm <sup>2</sup> max
+12V	Supply to remote unit	
DATA	Data to remote unit	
GND(s)	0v Terminal	
D1, D2	Option door contact**	
B1, B2	Option External switch*	
S1, S2	Option internal/external sensor***	
Pcb Fuses		Rating (A)
F1	T2A (slow blow)	
F2	T3.15A (slow blow)	

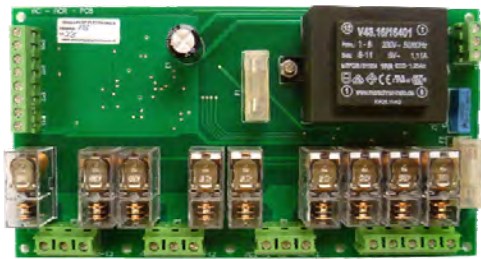
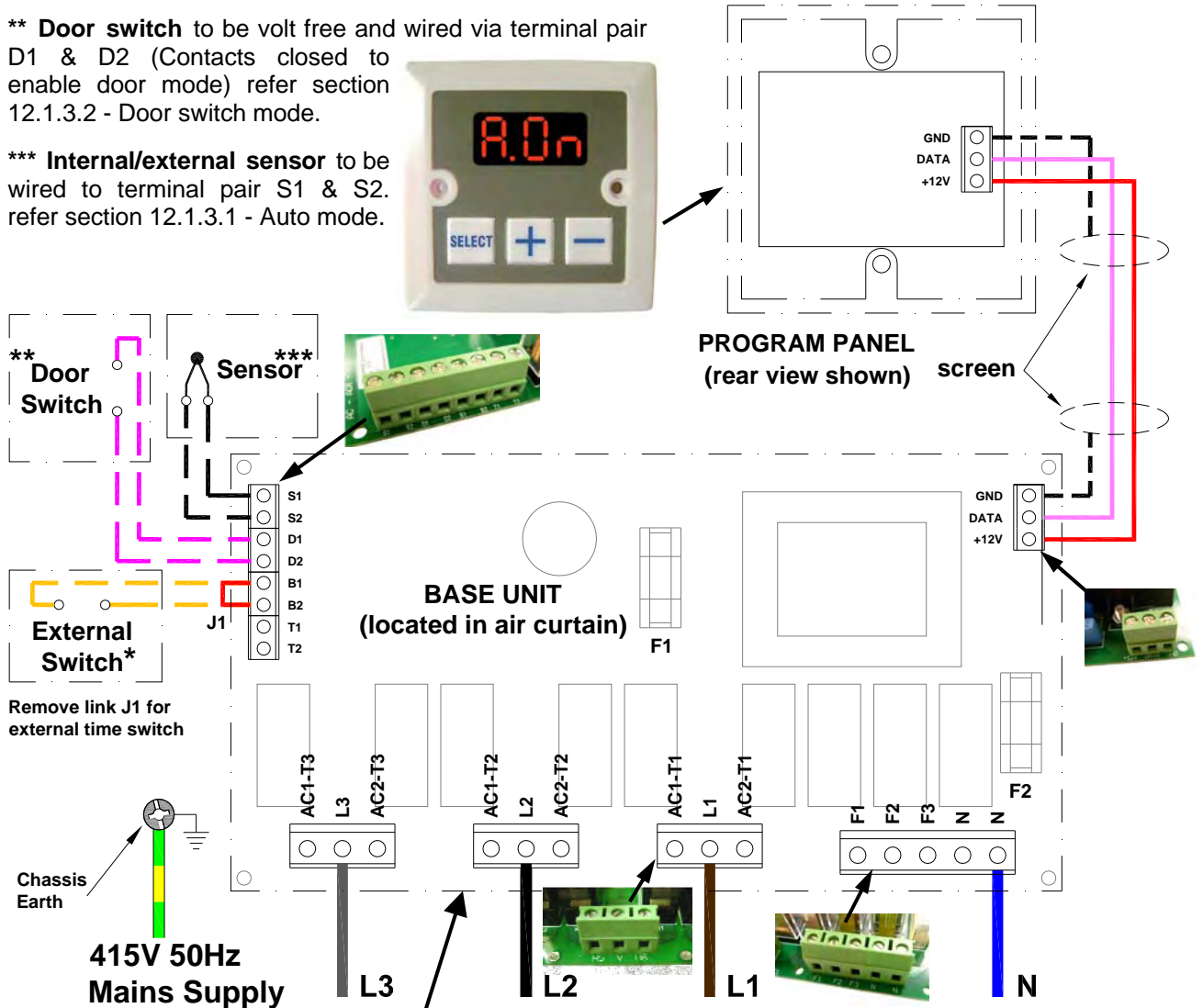
## 4.2 Installer Wiring - Electrically Heated 9 & 12kW THREE PHASE ONLY

The program panel is connected to the base unit via a set of 3 way connectors marked "+12V", "DATA" and "GND". Interconnecting wiring is via screened twisted pair 28AWG as shown. **Max length 50m.** It is recommended that this cable is run separately within its own trunking to avoid external interference.

\* **External switch** (ie BMS enable) to be volt free and wired via normally open contacts to terminal pair B1, B2. (Contacts closed to enable). Remove factory fitted jumper J1.

\*\* **Door switch** to be volt free and wired via terminal pair D1 & D2 (Contacts closed to enable door mode) refer section 12.1.3.2 - Door switch mode.

\*\*\* **Internal/external sensor** to be wired to terminal pair S1 & S2. refer section 12.1.3.1 - Auto mode.



Pcb Terminal	Description	Cable
N	Neutral	4mm <sup>2</sup> max
L1	3 phase supply	4mm <sup>2</sup> max
L2	3 phase supply	4mm <sup>2</sup> max
L3	3 phase supply	4mm <sup>2</sup> max
+12V	Supply to remote unit	Cable 1.0mm <sup>2</sup> max
DATA	Data to remote unit	
GND(s)	0v Terminal	
D1, D2	option door contact**	
B1, B2	option External switch*	
S1, S2	option internal/external Sensor***	
Pcb Fuses		Rating (A)
F1		T2A (slow blow)
F2		T3.15A (slow blow)

### Protection

External circuit breaker with the appropriate rating should be installed for the protection of the installation.

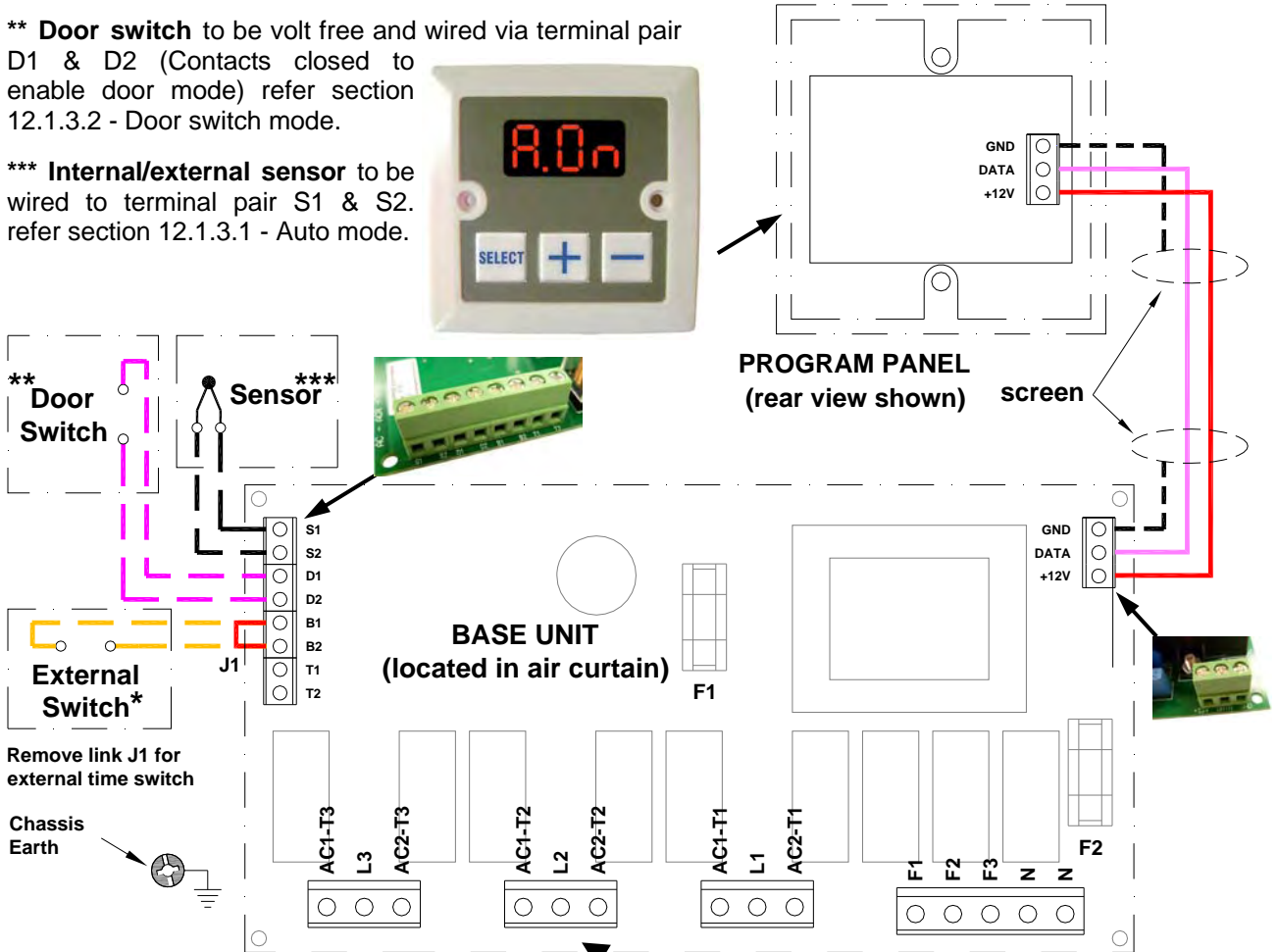
### 4.3 Installer Wiring - Electrically Heated 18 & 24kW THREE PHASE ONLY

The program panel is connected to the base unit via a set of 3 way connectors marked "+12V", "DATA" and "GND". Interconnecting wiring is via screened twisted pair 28AWG as shown. **Max length 50m.** It is recommended that this cable is run separately within its own trunking to avoid external interference.

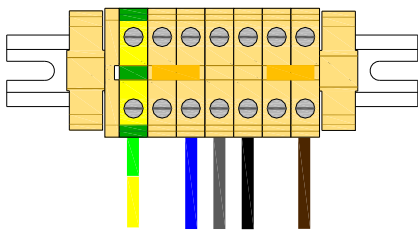
\* **External switch** (ie BMS enable) to be volt free and wired via normally open contacts to terminal pair B1, B2. (Contacts closed to enable). Remove factory fitted jumper J1.

\*\* **Door switch** to be volt free and wired via terminal pair D1 & D2 (Contacts closed to enable door mode) refer section 12.1.3.2 - Door switch mode.

\*\*\* **Internal/external sensor** to be wired to terminal pair S1 & S2. refer section 12.1.3.1 - Auto mode.



#### Contractors Terminal



**415V 50Hz  
Mains Supply**

#### Protection

External circuit breaker with the appropriate rating should be installed for the protection of the installation.



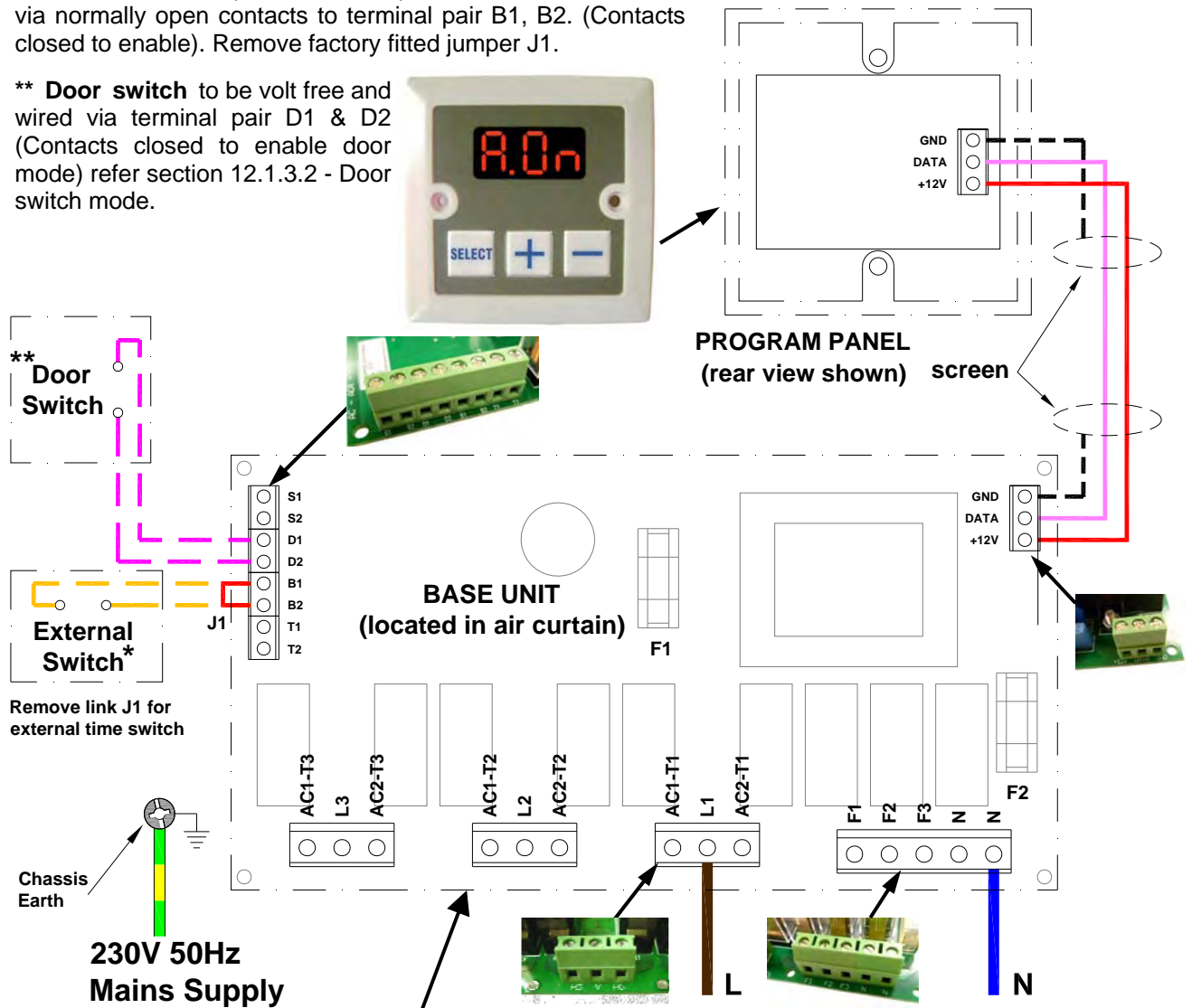
Terminal	Description	Cable
N	Neutral	6mm <sup>2</sup> max
L1	3 phase supply	6mm <sup>2</sup> max
L2	3 phase supply	6mm <sup>2</sup> max
L3	3 phase supply	6mm <sup>2</sup> max
Pcb Terminal	Description	Cable
+12V	Supply to remote unit	Cable 1.0mm <sup>2</sup> max
DATA	Data to remote unit	
GND(s)	0v Terminal	
D1, D2	Option door contact**	
B1, B2	Option External switch*	
S1, S2	Option internal/external sensor***	
Pcb Fuses	Rating (A)	
F1	T2A (slow blow)	
F2	T3.15A (slow blow)	

#### 4.4 Installer Wiring - Ambient

The program panel is connected to the base unit via a set of 3 way connectors marked "+12V", "DATA" and "GND". Interconnecting wiring is via screened twisted pair 28AWG as shown. **Max length 50m.** It is recommended that this cable is run separately within its own trunking to avoid external interference.

\* **External switch** (ie BMS enable) to be volt free and wired via normally open contacts to terminal pair B1, B2. (Contacts closed to enable). Remove factory fitted jumper J1.

\*\* **Door switch** to be volt free and wired via terminal pair D1 & D2 (Contacts closed to enable door mode) refer section 12.1.3.2 - Door switch mode.



Remove link J1 for external time switch

Chassis Earth

230V 50Hz Mains Supply



#### Protection

External circuit breaker with the appropriate rating should be installed for the protection of the installation.

Pcb Terminal	Description	Cable
N	Neutral	4mm <sup>2</sup> max
L	1 phase supply	4mm <sup>2</sup> max
+12V	Supply to remote unit	Cable 1.0mm <sup>2</sup> max
DATA	Data to remote unit	
GND(s)	0v Terminal	
D1, D2	Option door contact**	
B1, B2	Option External switch*	
<b>Pcb Fuses</b>	<b>Rating (A)</b>	
F1	T2A (slow blow)	
F2	T3.15A (slow blow)	

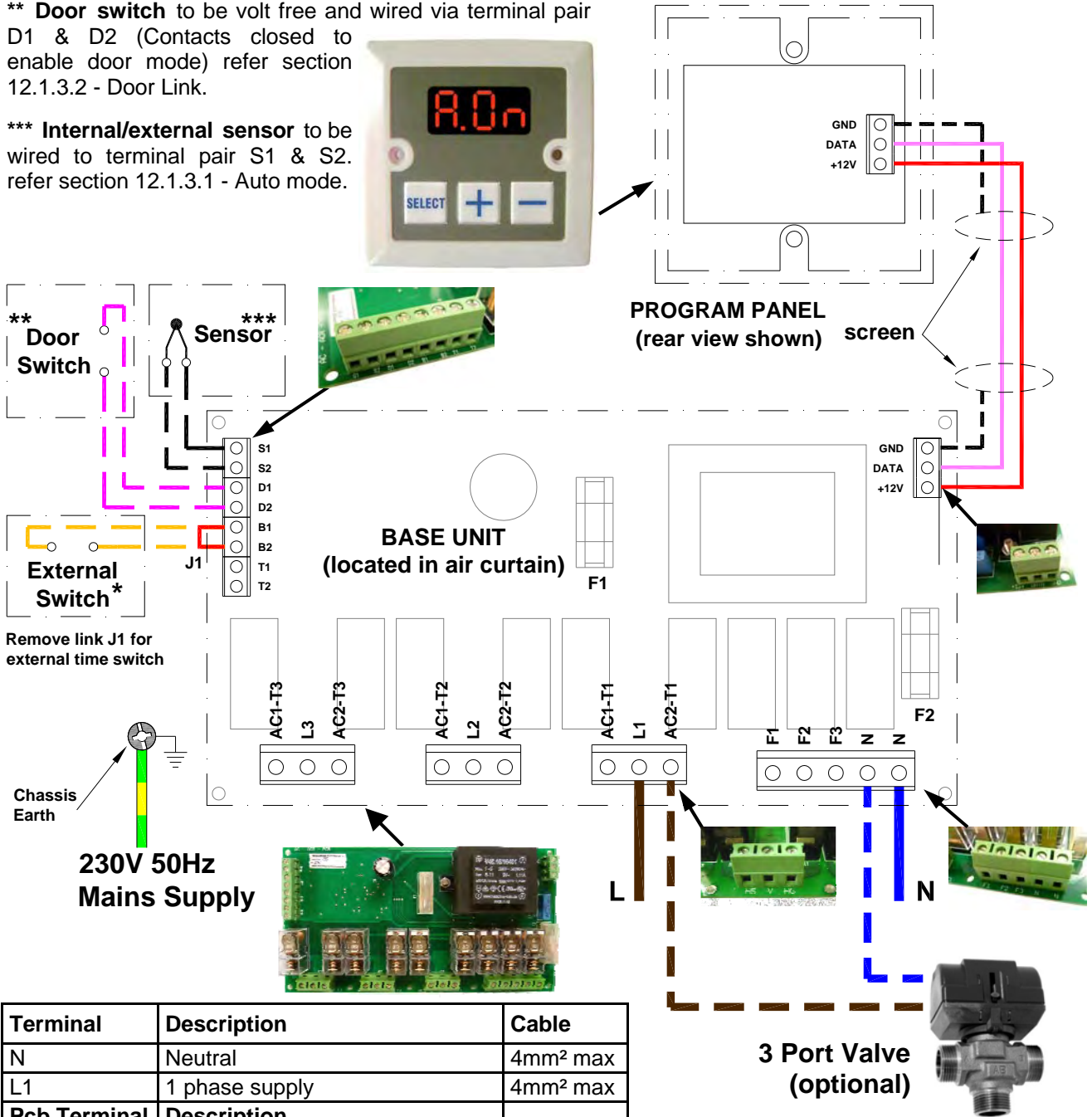
### 4.5 Installer Wiring - LPHW

The program panel is connected to the base unit via a set of 3 way connectors marked "+12V", "DATA" and "GND". Interconnecting wiring is via screened twisted pair 28AWG as shown. **Max length 50m.** It is recommended that this cable is run separately within its own trunking to avoid external interference.

\* **External switch** (ie BMS enable) to be volt free and wired via normally open contacts to terminal pair B1, B2. (Contacts closed to enable). Remove factory fitted jumper J1.

\*\* **Door switch** to be volt free and wired via terminal pair D1 & D2 (Contacts closed to enable door mode) refer section 12.1.3.2 - Door Link.

\*\*\* **Internal/external sensor** to be wired to terminal pair S1 & S2. refer section 12.1.3.1 - Auto mode.



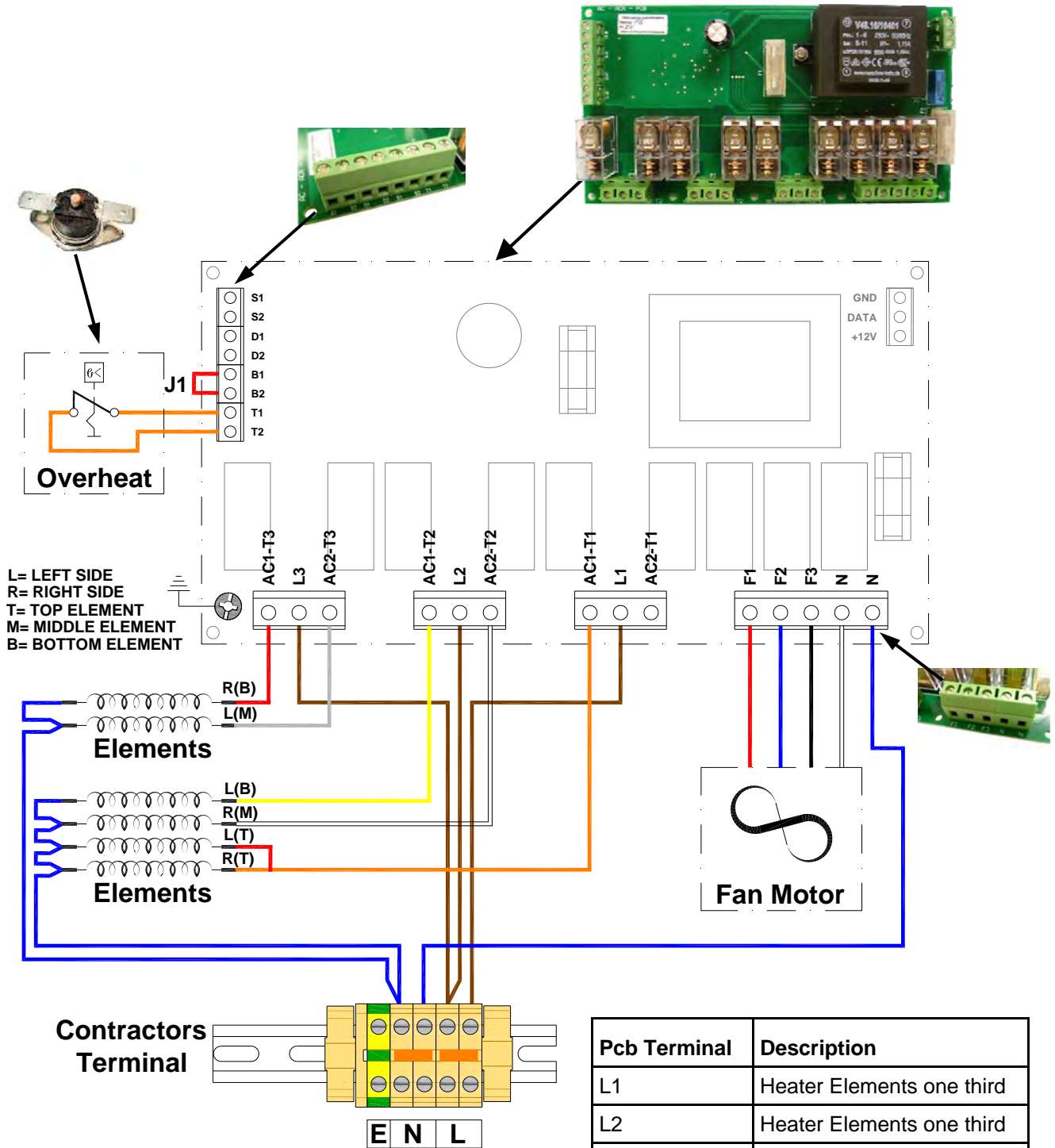
Terminal	Description	Cable
N	Neutral	4mm <sup>2</sup> max
L1	1 phase supply	4mm <sup>2</sup> max
Pcb Terminal	Description	Cable 1.0mm <sup>2</sup> max
12V	Supply to remote unit	
DATA	Data to remote unit	
GND(s)	0v Terminal	
D1, D2	Option door contact**	
B1, B2	Option External switch*	
S1, S2	Option internal/external sensor***	
Pcb Fuses	Rating (A)	
F1	T2A (slow blow)	
F2	T3.15A (slow blow)	

Optional 3 port valve to be wired to terminals AC1T1 and N.

#### Protection

External circuit breaker with the appropriate rating should be installed for the protection of the installation.

#### 4.6 Factory Wiring - Electrically heated 6 & 9kW SINGLE PHASE ONLY

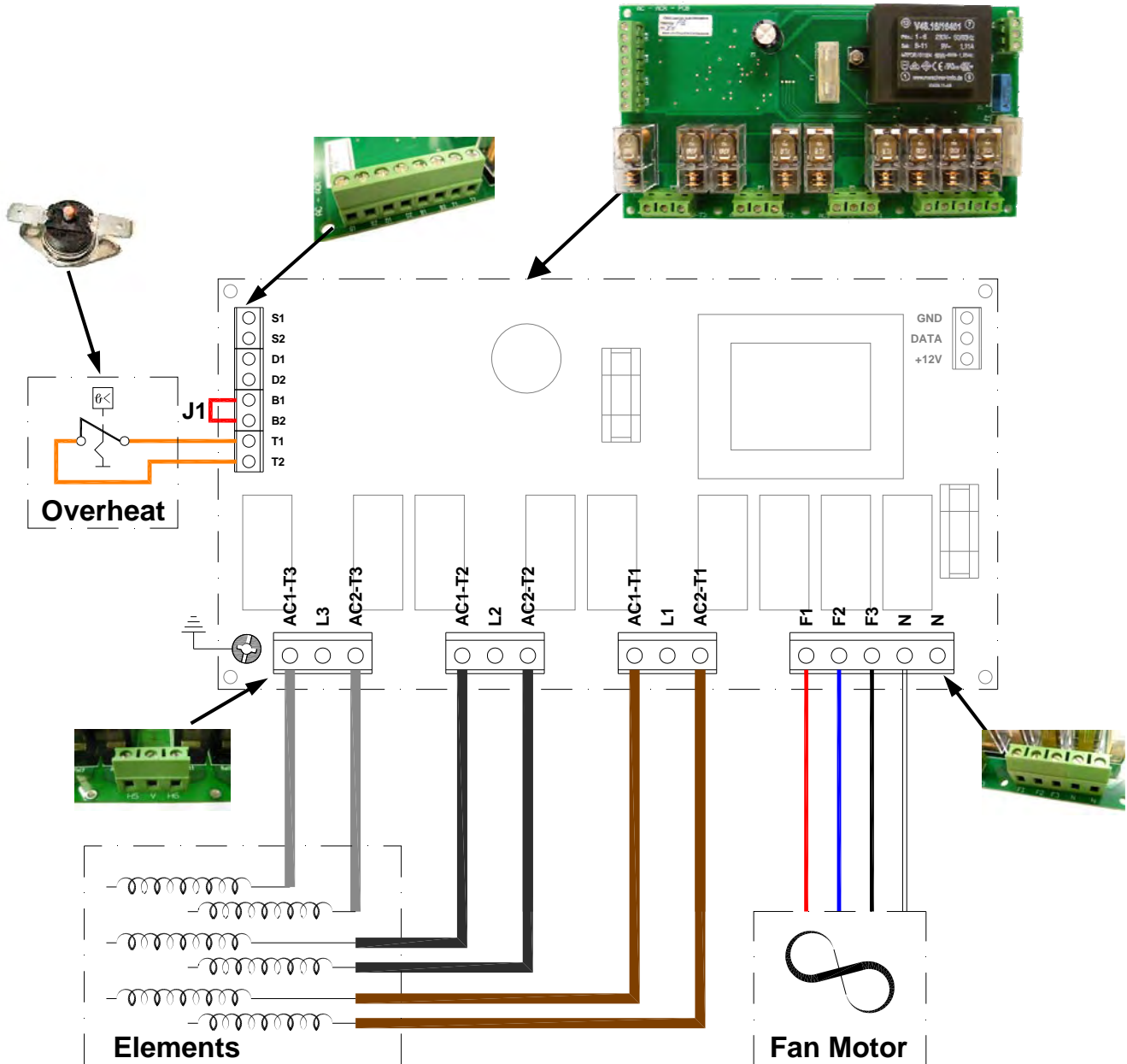


The element output is connected to the right and left side of each terminal block marked "AC1-T1", "AC2-T1", AC1-T2", "AC2-T2", "AC1-T3" and "AC2-T3"

The fan output is connected to a 4 way connector marked "N", "F1", "F2" and "F3".

The thermal trip is connected to a 2 way connector marked "T1" & "T2"

4.7 Factory Wiring - Electrically heated 9 & 12kW THREE PHASE ONLY



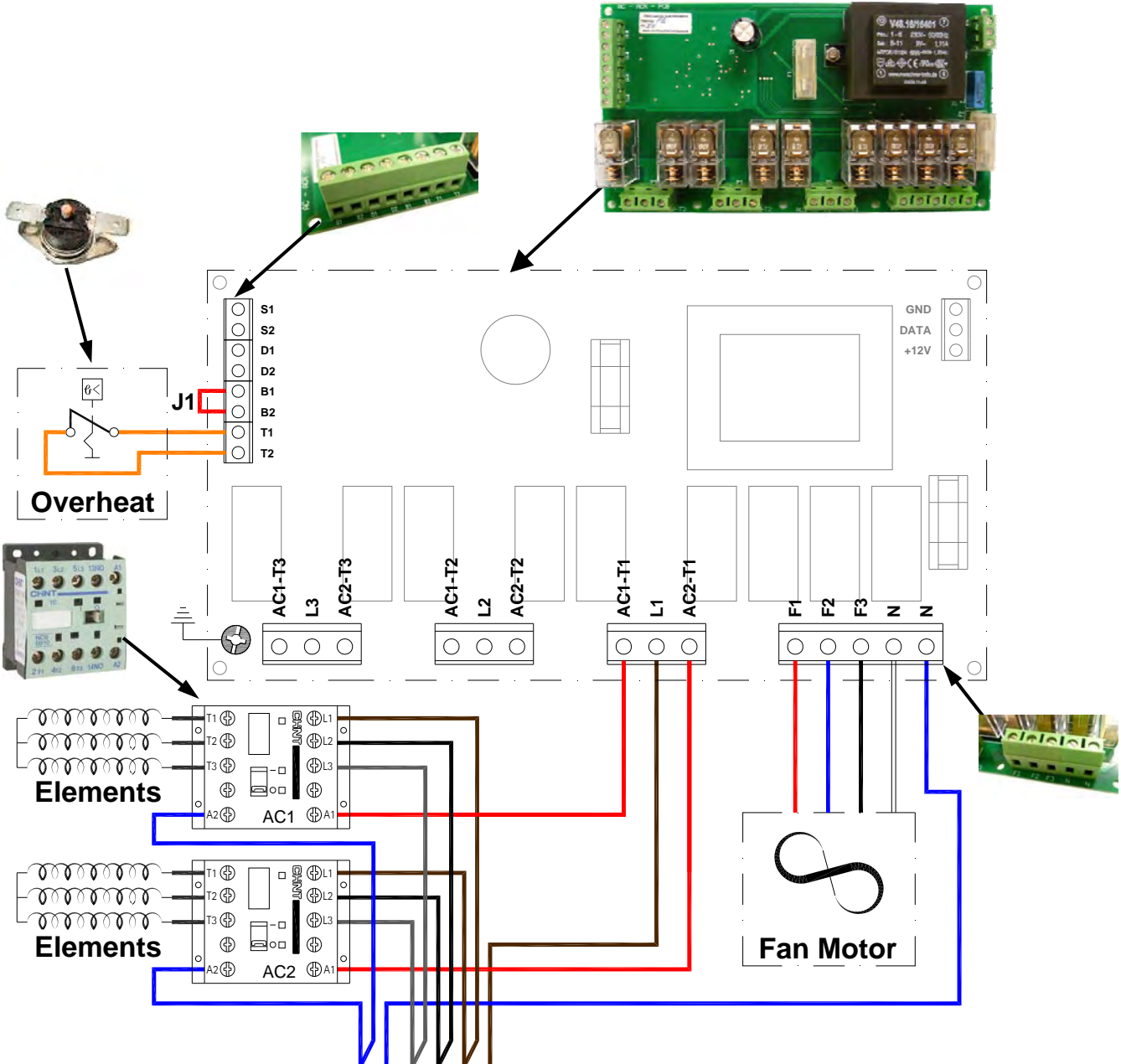
Pcb Terminal	Description
L1	Heater Elements phase 1
L2	Heater Elements phase 2
L3	Heater Elements phase 3
N	Neutral to fan
F1	Fan - low speed
F2	Fan - medium speed
F3	Fan - high speed
T1	Thermal Overheat trip
T2	Thermal Overheat trip
J1	Factory BMS link

The element output is connected to the right and left side of each terminal block marked "AC1-T1", "AC2-T1", "AC1-T2", "AC2-T2", "AC1-T3" and "AC2-T3"

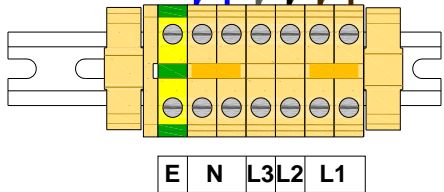
The fan output is connected to a 4 way connector marked "N", "F1", "F2" and "F3".

The thermal trip is connected to a 2 way connector marked "T1" & "T2"

**4.8 Factory Wiring - Electrically heated 18 & 24kW THREE PHASE ONLY**



**Contractors Terminal**



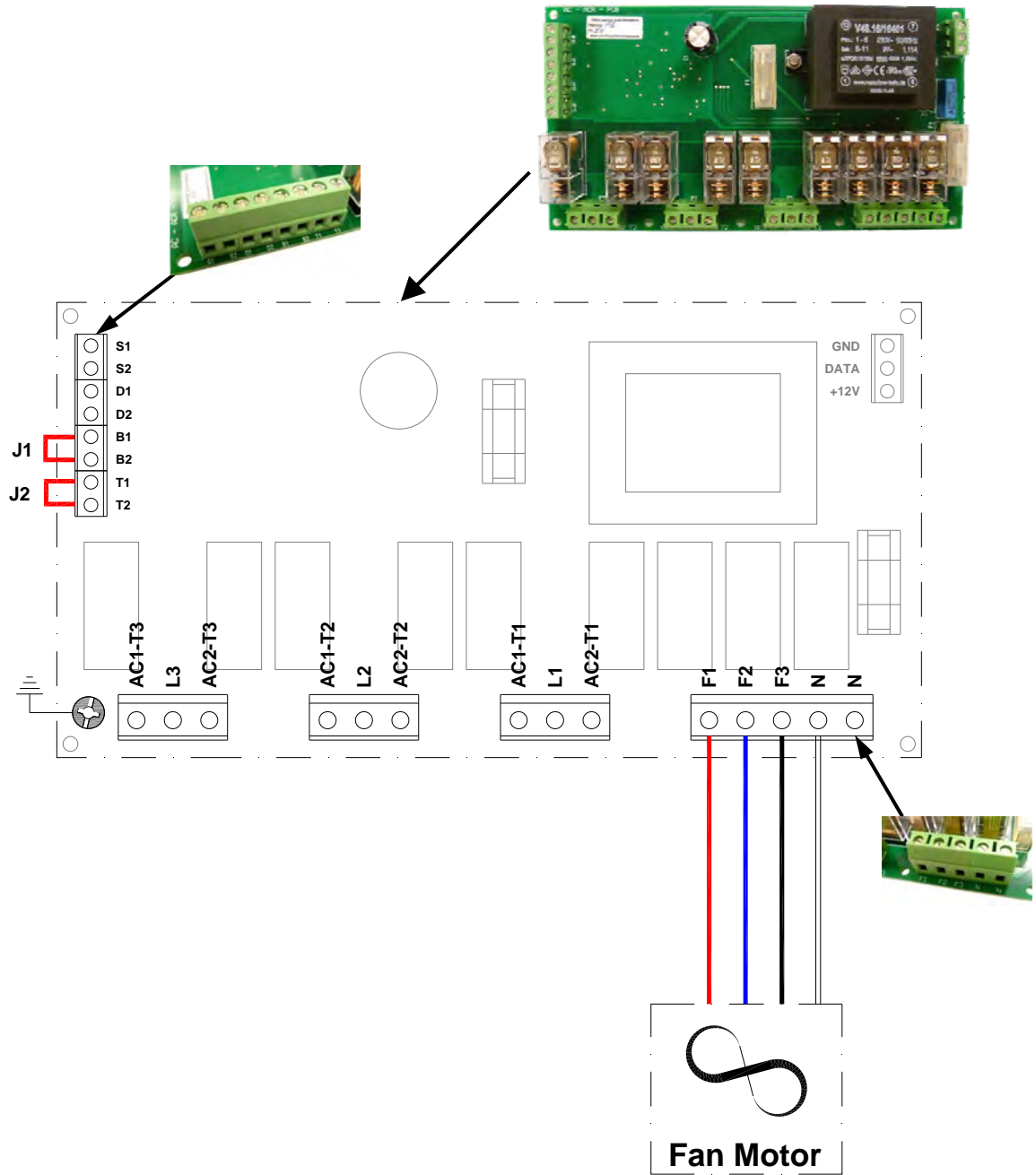
Pcb Terminal	Description
AC1/2-T1	Heater Elements phase 1
AC1/2-T2	Heater Elements phase 2
AC1/2-T3	Heater Elements phase 3
T1	Thermal Overheat trip
T2	Thermal Overheat trip
N	Neutral to fan
F1	Fan - low speed
F2	Fan - medium speed
F3	Fan - high speed
J1	Factory BMS link

The element outputs are connected to contactors "AC1" and "AC2" on terminals T1, T2 and T3.

The fan output is connected to a 4 way connector marked "N", "F1", "F2" and "F3".

The thermal trip is connected to a 2 way connector marked "T1" & "T2"

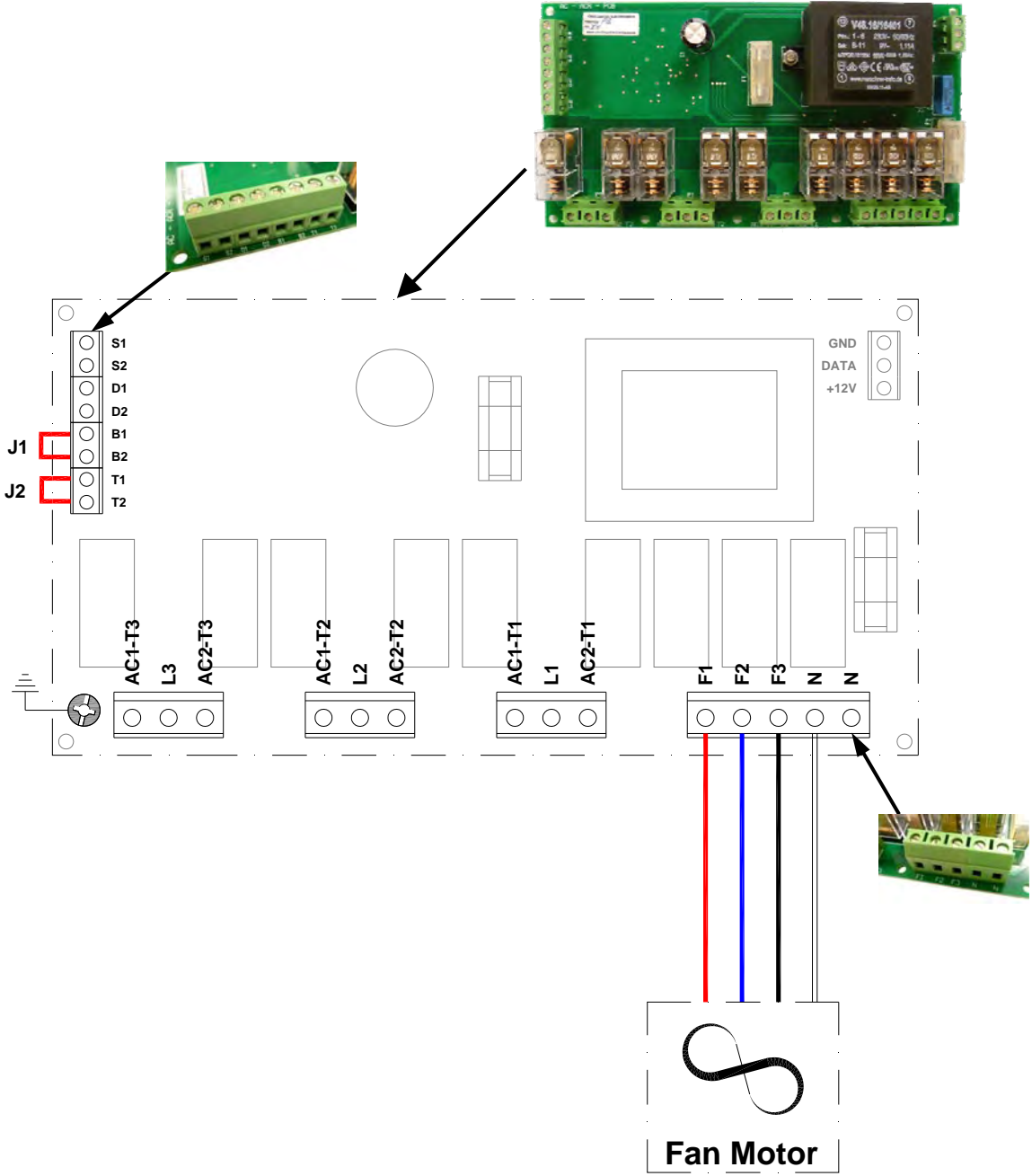
## 4.9 Factory Wiring - Ambient



Pcb Terminal	Description
N	Neutral to fan
F1	Fan - low speed
F2	Fan - medium speed
F3	Fan - high speed
J1	Factory BMS link
J2	Factory thermal link

The fan output is connected to a 4 way connector marked "N", "F1", "F2" and "F3".

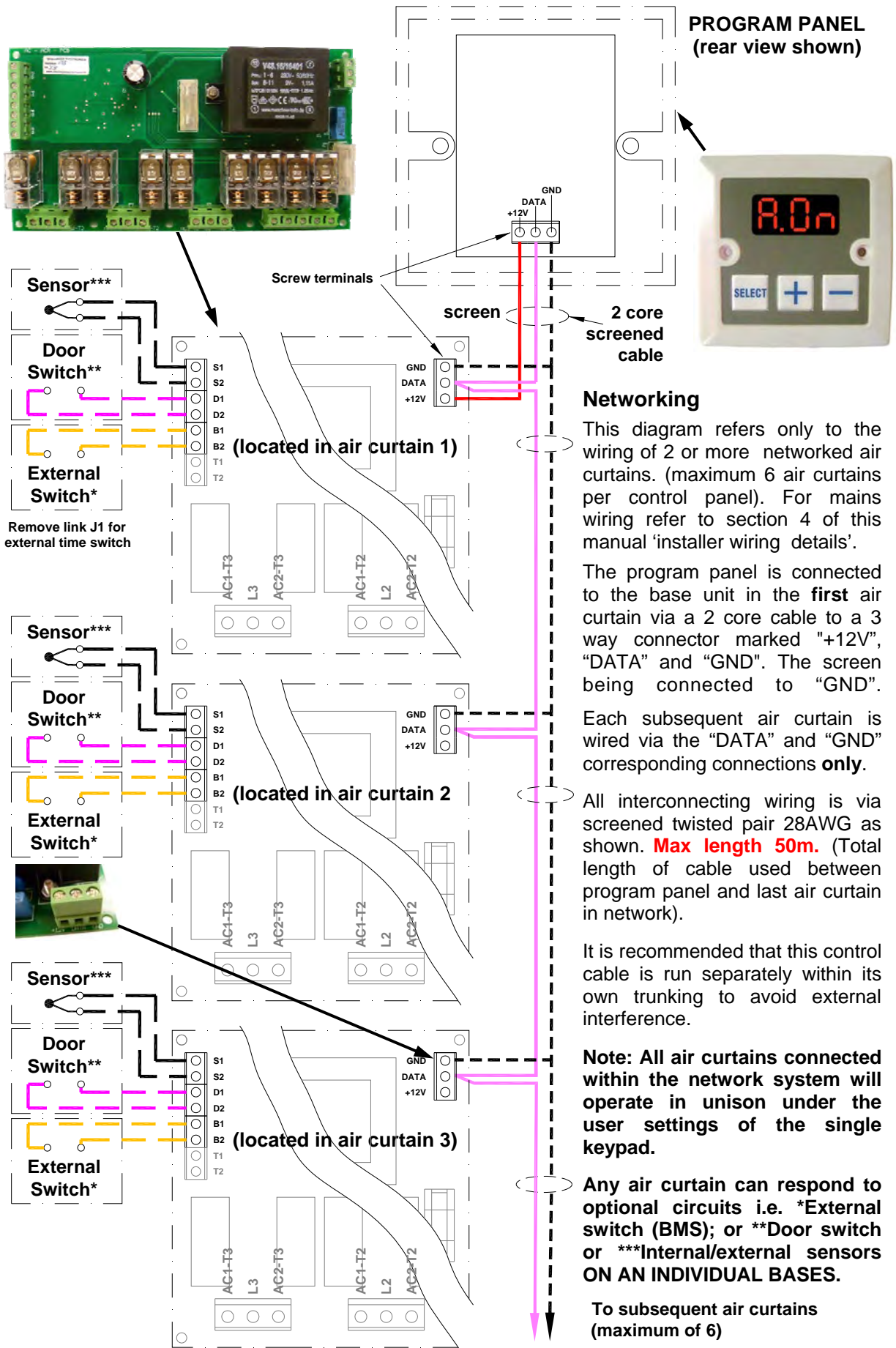
### 4.10 Factory Wiring - LPHW



Pcb Terminal	Description
N	Neutral to fan
F1	Fan - low speed
F2	Fan - medium speed
F3	Fan - high speed
J1	Factory BMS link
J2	Factory thermal link

The fan output is connected to a 4 way connector marked "N", "F1", "F2" and "F3".

### 4.11 Network Wiring - Electronic controller



#### Networking

This diagram refers only to the wiring of 2 or more networked air curtains. (maximum 6 air curtains per control panel). For mains wiring refer to section 4 of this manual 'installer wiring details'.

The program panel is connected to the base unit in the **first** air curtain via a 2 core cable to a 3 way connector marked "+12V", "DATA" and "GND". The screen being connected to "GND".

Each subsequent air curtain is wired via the "DATA" and "GND" corresponding connections **only**.

All interconnecting wiring is via screened twisted pair 28AWG as shown. **Max length 50m.** (Total length of cable used between program panel and last air curtain in network).

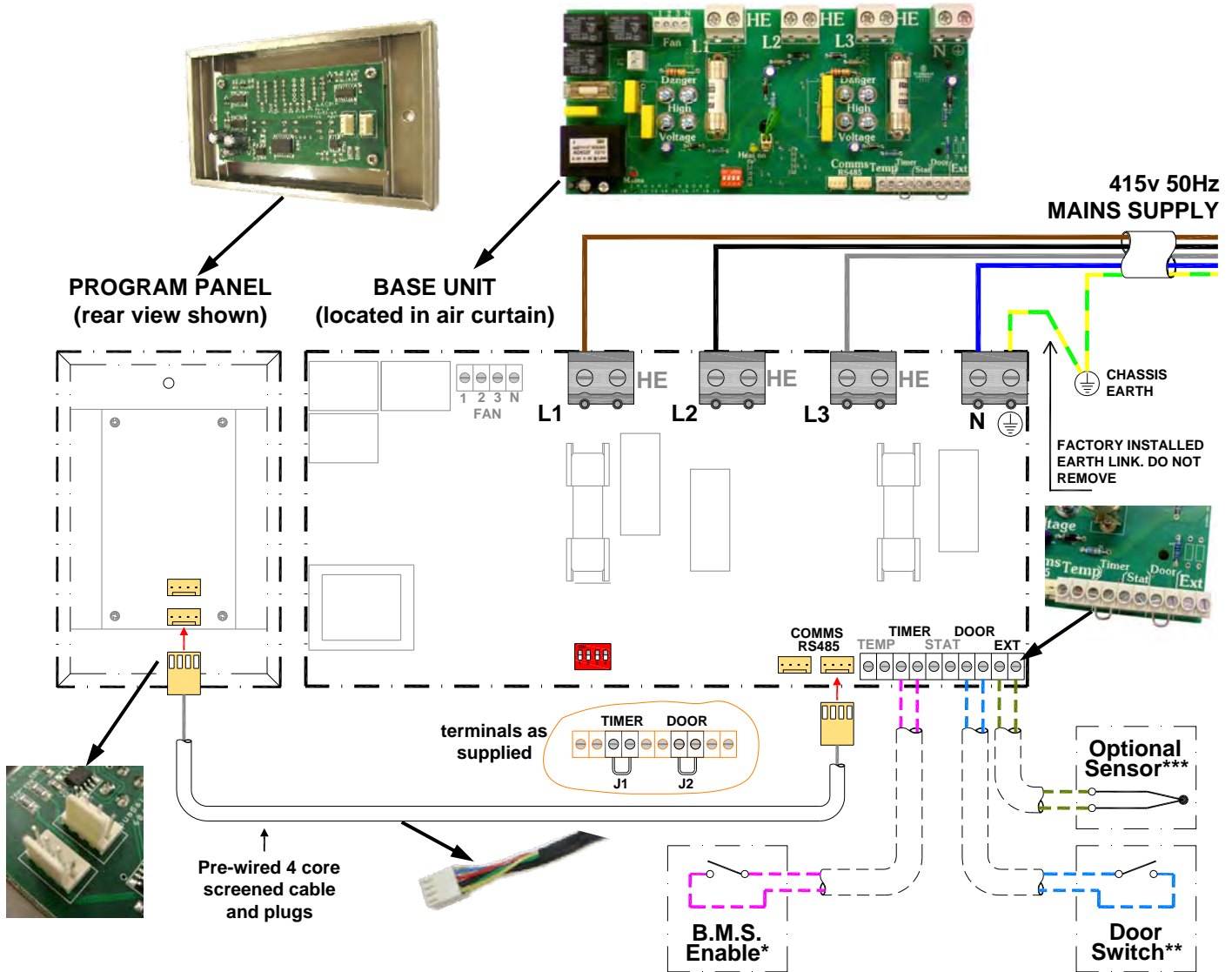
It is recommended that this control cable is run separately within its own trunking to avoid external interference.

**Note: All air curtains connected within the network system will operate in unison under the user settings of the single keypad.**

**Any air curtain can respond to optional circuits i.e. \*External switch (BMS); or \*\*Door switch or \*\*\*Internal/external sensors ON AN INDIVIDUAL BASES.**

To subsequent air curtains (maximum of 6)

## 4.12 Installer wiring diagram Electrically heated with SmartElec2 control.



### Interconnecting wiring

The program panel is connected to the base unit via a set of pre-wired 4 core screened cables with pre-wired plugs as shown.

Interconnecting wiring is via a 4 core screened cable with pre-wired plugs, supplied in 2, 10, 20, 30, 50 and 100m lengths.

It is recommended that this control cable is run separately within its own trunking to avoid external interference.

### Optional wiring

\* **External switch** (ie BMS enable) to be volt free and wired via normally open contacts to terminal pair 'TIMER'. (Contacts closed to enable). Remove factory fitted jumper J1.

\*\* **Door switch** to be volt free and wired via normally closed contacts to terminal pair 'DOOR'. (Contacts open to enable door mode). Remove factory fitted jumper J2. refer section 10.2.6.1 - Door link settings.

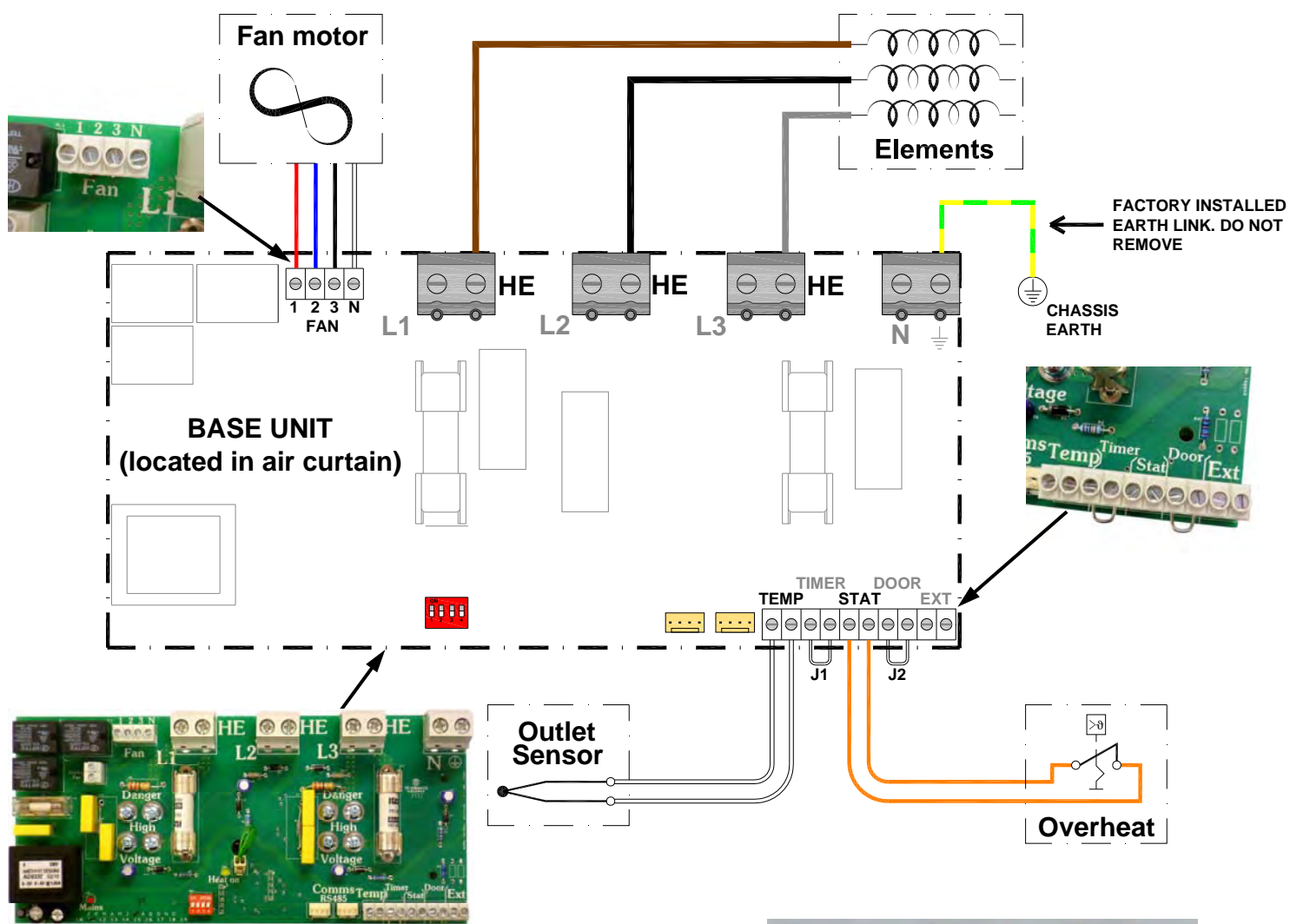
\*\*\* **Internal/external sensor** to be wired to terminal pair 'EXT'. refer section 10.2.6.4 - External Temperature.

### Protection

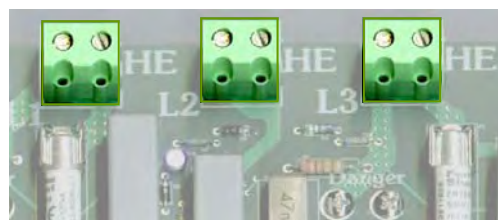
There are two high speed fuses on the base unit to protect the switching thyristors for the heater. An external circuit breaker with the appropriate rating should be installed for the protection of the installation.

Terminal	Description	Cable
N	Neutral	10mm <sup>2</sup> max
L1	3 phase supply	10mm <sup>2</sup> max
L2	3 phase supply	10mm <sup>2</sup> max
L3	3 phase supply	10mm <sup>2</sup> max
E	Mains earth	10mm <sup>2</sup> max
Timer*	BMS pair (volt -free)	1.5mm <sup>2</sup> max
Door**	Door interlock pair, n.c. (volt free)	1.5mm <sup>2</sup> max
Ext***	External sensor pair (non-polarised)	1.5mm <sup>2</sup> max

#### 4.13 Factory Installed Wiring. Electrically Heated with SmartElec2 Control.



Terminal	Description	Cable
HE	Heating elements phase 1	10mm <sup>2</sup> max
HE	Heating elements phase 2	10mm <sup>2</sup> max
HE	Heating elements phase 3	10mm <sup>2</sup> max
N	Neutral to fan	1.5mm <sup>2</sup> max
1	Fan - low speed	1.5mm <sup>2</sup> max
2	Fan - medium speed	1.5mm <sup>2</sup> max
3	Fan - high speed	1.5mm <sup>2</sup> max
Temp	Air sensor pair (non-polarised)	1.5mm <sup>2</sup> max
Stat	Ext thermal trip pair, n.c. (volt-free)	1.5mm <sup>2</sup> max
Comms	Keypad/network connectors	Pre-wired



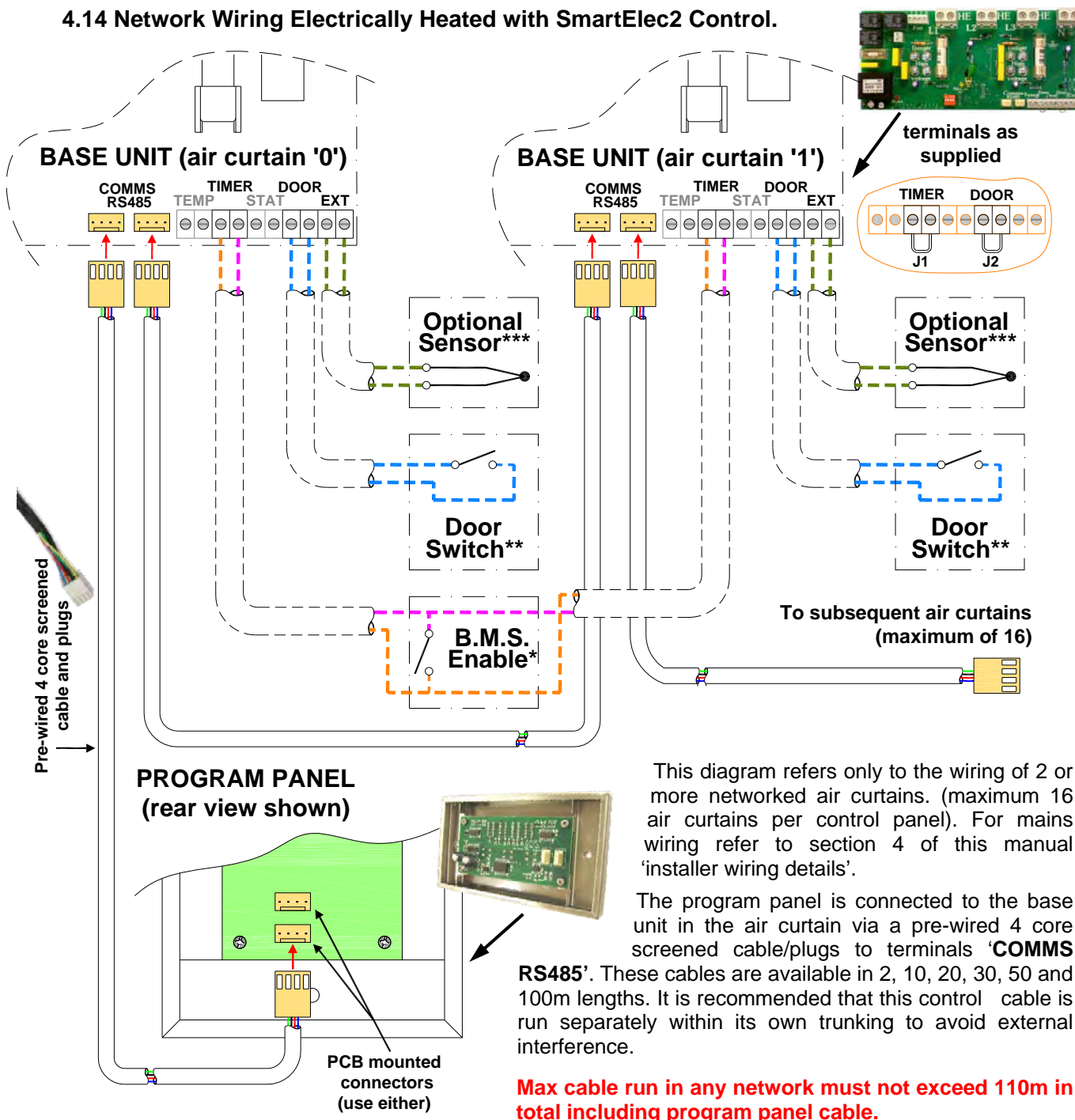
The heater element outputs are connected to the right hand side of three terminal blocks and are marked 'HE'. (See below).

The fan output is connected to a 4 way terminal block marked 'N, 1, 2 and 3'.

The sensor input (air sensor) is connected to 2 terminals marked 'TEMP' on the base unit. The sensor is not polarity sensitive.

The external thermal trip (volt-free) is connected to 2 terminals marked 'STAT' on the base unit. The terminals are not polarity sensitive.

#### 4.14 Network Wiring Electrically Heated with SmartElec2 Control.



This diagram refers only to the wiring of 2 or more networked air curtains. (maximum 16 air curtains per control panel). For mains wiring refer to section 4 of this manual 'installer wiring details'.

The program panel is connected to the base unit in the air curtain via a pre-wired 4 core screened cable/plugs to terminals 'COMMS RS485'. These cables are available in 2, 10, 20, 30, 50 and 100m lengths. It is recommended that this control cable is run separately within its own trunking to avoid external interference.

**Max cable run in any network must not exceed 110m in total including program panel cable.**

**Note: All air curtains connected within the network system will operate under the settings of the single keypad.**

- Any air curtain within the network can be connected with and respond to the following optional circuits:
- \* **External switch** (ie BMS enable) where required, to be volt free and wired **in PARALLEL** via normally open contacts to each terminal pair 'TIMER'. (Contacts closed to enable). Only air curtain(s) wired this way will respond to the enable signal. Remove factory fitted jumpers J1. (**NOTE: terminals are polarity sensitive**)
  - \*\* **Door switches** where required, to be volt free and wired to **INDIVIDUAL** base units via normally closed contacts to each terminal pair 'DOOR'. (Contacts open to enable door mode). Only air curtain(s) wired this way will respond to the door mode. Remove factory fitted jumper J2. refer section 12.2.6.1 - Door link settings.
  - \*\*\* **Internal/external sensors**, where required, to be wired to **INDIVIDUAL** base units to each terminal pair 'EXT'. Only air curtain(s) wired this way will respond to the sensor setting. If a sensor is fitted to more than one air curtain then the value is displayed as an average. refer section 12.2.6.4 - External temperature.

## 5. Installation Details.

### 5.1 Mounting

Airbloc units should be installed horizontally directly over the door opening. It is recommended that the air curtain is installed on the inside of the building, within the open room space against a wall or ceiling.

Care must be taken to allow complete free air movement into the inlet grilles of the unit to ensure correct working operation of the air curtain. The discharge opening should be as close to the top of the door as possible and to cover the entire door width.

Units can be mounted adjacent to each other to cover the full door opening across wider entrances.

These units are designed for surface mounting and should not be placed into a ceiling void, due to possible obstruction of airflow and difficulty in routine cleaning and maintenance.

### 5.2 Electrical Supply.


These units are suitable for connection to a 415 Volt, 50Hz 3 phase and neutral supply for Electrically heated 9-24kW models or 230/240 Volt 50 Hz single phase supply for Electrically heated 6kW, 9kW, Ambient and LPHW models.

Electrically heated models consume 6kW and 9kW at 230 volts and 9kW, 12kW, 18kW & 24kW at 415 Volts when switched to the full heat position depending on their model and capacity size .

The appliance shall be connected to the supply via an appropriate switched fused double pole isolator having a contact separation of greater than 3mm. Test for correct operation and refit the cover.

For connection to the mains supply it will be necessary to remove the outer cover from the unit. After removing the cover you will note the mains terminal block and it will be necessary to connect the mains supply and the lead from the remote switch box prior to refitting the cover. Wire in accordance to diagrams in section 4.1 to 4.5.

For optional SmartElec2 controller, wire as shown in diagrams 4.12 to 4.14

 For safety reasons, a sound earth connection must always be made to the unit before it is put to use. The unit should be wired in accordance with IEE Regulations for the Electrical Equipment of Buildings.

### 5.3 Installation.

It is the sole responsibility of the installer to ensure that the points of attachment to the building are sound. Consultation with the consultant/architect or owner of the building is recommended to ensure that a sound, mechanically stable installation is achieved.

All attachments must be capable of supporting the weight of the product detailed in Section 3.

#### Step 1



Remove all packaging. Remove decorative cover. Undo screws securing the outlet. (not Chassis version)

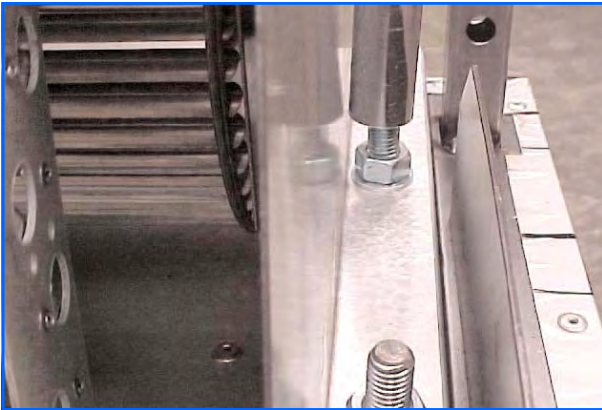
*Note All outer metal surfaces are covered by a protective plastic film, which must be removed before final fixing and operating of the unit.*

#### Step 2



Carefully remove the air curtain front cover by removing four screws (not Chassis version)

### Step 3



It is recommended that the chassis is removed from the back box to avoid having to support the weight of the product during installation.

To separate the chassis from the back box undo and remove the nuts shown and lift the chassis away from the back box.

The product can be installed using either M12 drop rods or fastened direct to the wall using appropriate sized fixings suitable for the wall surface and the weight of the product.

### Step 4

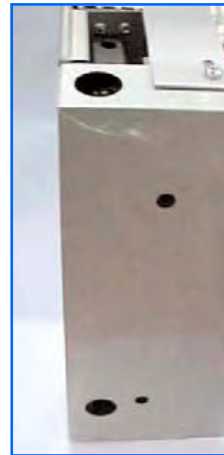


To wall mount the product, position the back box against the wall at the desired mounting height and mark through the holes in the back box brackets to enable the wall to be drilled for the appropriate fixings.

### Step 5

Drill the wall then fix the backbox in position. Lift the chassis (using lifting gear if necessary) onto the studs on the back box brackets. Refit and tighten the nuts.

### Step 6



Holes are provided in the back box for the feed cable to enter the case. Choose the appropriate hole top rear to suit the installation.

Fit suitable cable gland for size of cable.

### Step 7



To install the product using M12 drop rods follow instructions from step 4. If the decorative tube is to be used, fit this over the drop rod, then pass the drop rod through the back box brackets.

### Step 8

Adjust the product to the required height and ensure that it is fitted level using a spirit level across the back box as required.

Tighten the lock nuts and re-assemble in reverse order. Adjust outlet to required angle to give desired performance, and tighten outlet screws.

### 5.4 Installation details - AC-ACR-PANEL programmer

The Electronic base unit is pre-installed inside the air curtain. All the external electrical connections are via screw terminals onto this base unit.

The program keypad is installed on a separate facia plate and connected to a surface mounted back box in a suitable location. Please see fig 5.

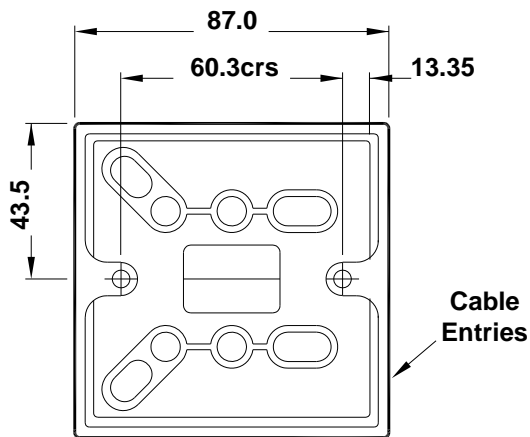


Fig. 5. Surface mount location holes.

Alternatively, the program panel can be flush wall mounted with the addition of a suitable conduit box MK part number 861 ZIC or equivalent.

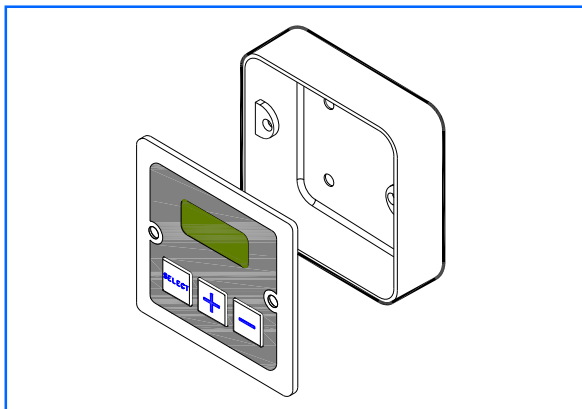


Fig. 6. Alternative conduit box

The distance between the base unit and the program panel can be up to 50m maximum.

### 5.5 Installation details - Option SmartElec2 Controller

The SmartElec2 base unit is pre-installed inside the air curtain. All the external electrical connections are via screw terminals onto this base unit.

The SmartElec2 program panel is installed in a separate housing and connected to a surface mounted back box in a suitable location. Please see fig 7.

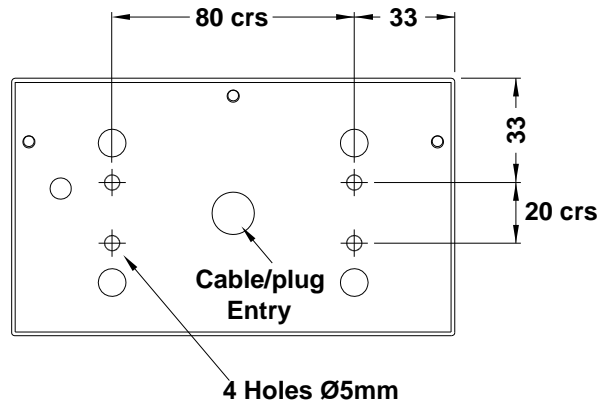


Fig. 7. Surface mount location holes.

Alternatively, the program panel can be flush wall mounted with the addition of a suitable conduit box MK part number 892 ALM or equivalent.

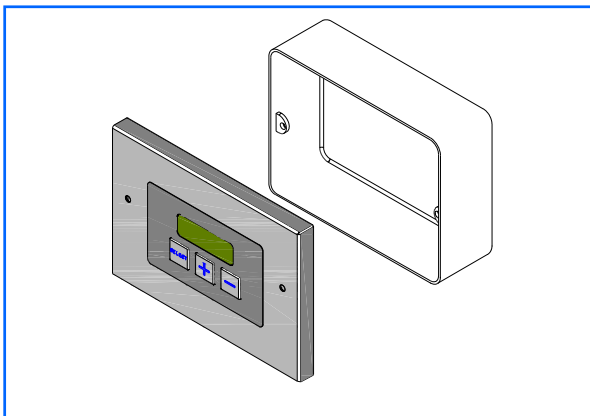


Fig. 8. Alternative conduit box

The distance between the base unit and the program panel can be up to 100m maximum.

## 5.6 Installation details - LPHW Only

Installation of the LPHW unit is as described earlier. Once situated, access to the heating coil and controller base unit is via removal of the case front.

The LPHW copper tubing connections are as shown in fig.9 below and are 15mm outside diameter. Ensure correct water seal fittings are used. We recommend the use of a suitable water mains isolation valve to ease any maintenance.

The unit is handed for right hand pipe connection.

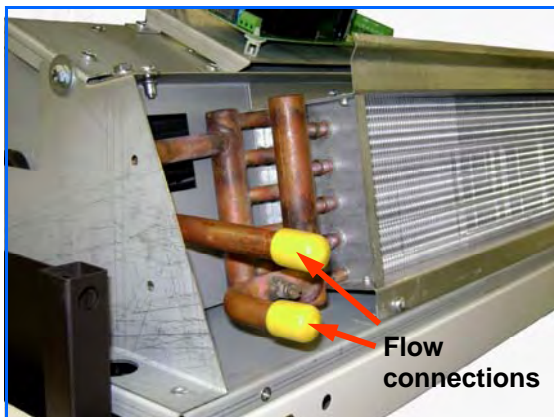


Fig. 9. LPHW connections.

### 5.6.1 Three Port Valve

An optional 3 port valve (supplied by others) can be used on the flow and return pipes to divert the hot water from the unit when not in use.

The valve must be fitted in accordance with the manufactures instructions.

When used in conjunction with the standard AC-ACR programmer, the 3 port valve can be wired into the base unit to open the valve when heat is selected (see section 4.5). This valve must operate on 230V.

**Note: This option can not operate with a SmartElec unit.**



AIRCURTAIN

## 5.7 Installation wiring

With the air curtain cover removed and chassis exposed, connect the electrical supply and program panel interconnecting wiring/factory supplied cables to the relevant terminals on the controller base unit.

Connect any interconnecting wiring/factory supplied cables to the programme panel.

Connect any optional wiring as required.

For full details see wiring diagrams in section 4. Ensure the correct diagram is used based on the information from the air curtain data plate and optional manufactures information

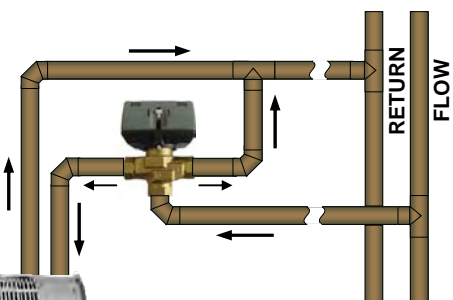
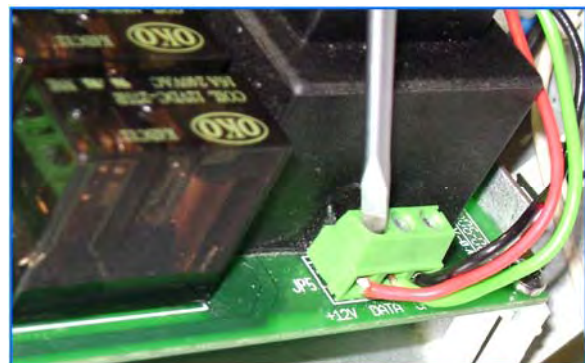
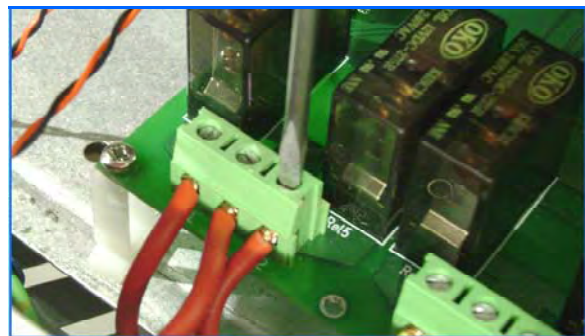
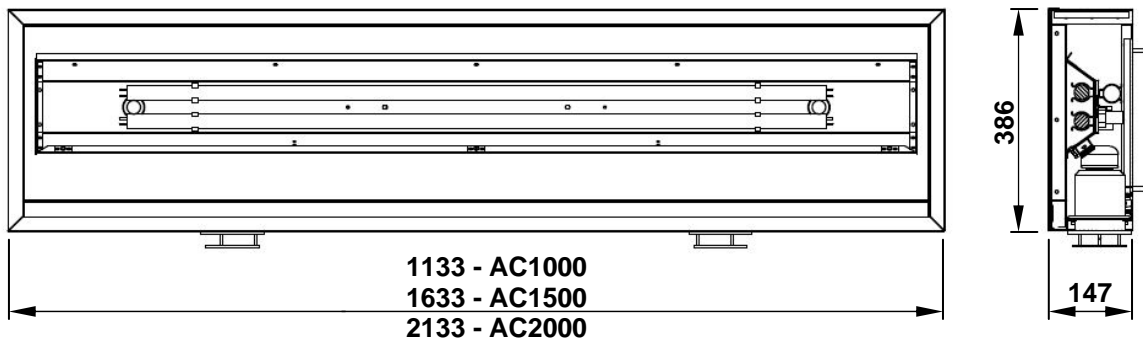


Fig.10 Typical schematic of a 3 port valve system

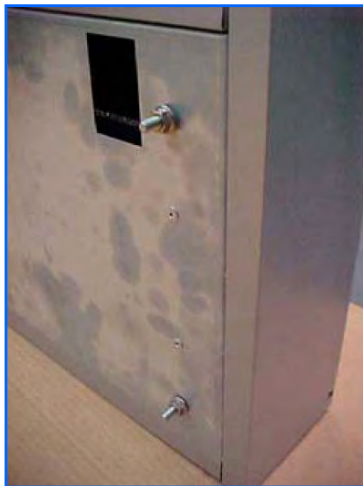
## 6. Optional Light Box/Down lighters.

### 6.1 Dimensions.



### 6.2 Installation.

To enable the light box to be attached to the air curtain, there are 4 studs/nuts on the back of the light box.



Ensure that the power is isolated from the air curtain and remove the decorative case from the air curtain.

Note at the side of the air curtain fixing brackets that there are holes of the correct size and centres to attach the light box to the air curtain.



Remove the nuts from the studs. Lift and support the light box (using suitable equipment as

necessary) and put the studs through the mating holes on the air curtain.

Note:- there is a cable coming out of the light box to enable the lights to be powered. Take care when fitting and pass the cable thro the mating hole in the air curtain.



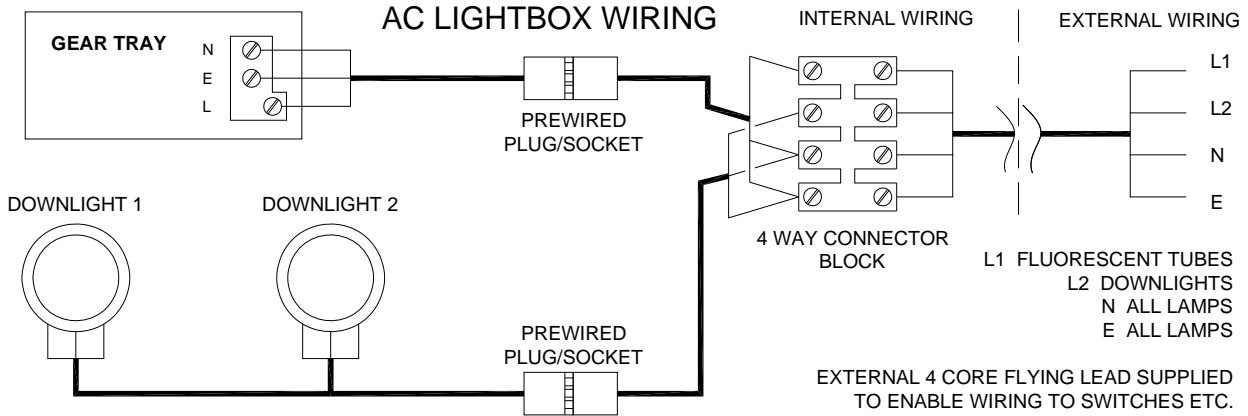
Continue to support the light box and using a suitable socket tighten the nuts to make the air curtain and light box a complete assembly.

There are M10 cage nuts in the top of the light box that allow drop rods to be used to provide support to the complete assembly.



Decorative extrusions are available from the manufacturer to cover the drop rod. Please note that these extrusions need to be fitted at the time of installation.

### 6.3 Wiring.

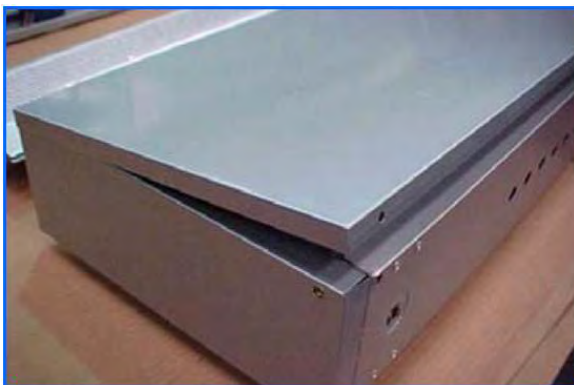


The flying lead from the light box needs to be routed to the mains terminal block on the air curtain and the L, N, & Earth wires connected appropriately.



### 6.4 Rear Panel & Sign Options.

Provided as standard with the product is a rear panel.



Behind the rear panel are the fluorescent tubes that can be used to illuminate an acrylic sign with appropriate branding for the premises (supplied by end user).

Please note that the fluorescent tube connectors are detached at our factory, and these need to be re-connected on-site if the optional acrylic sign is used.

If an acrylic branding sign is required, then remove the rear panel and use the 2 off L shaped frames provided to fasten the sign in place.



## 7. Optional Fire Exit Luminaire.



### 7.1 General

All emergency lighting luminaires supplied are designed and manufactured to conform with relevant British Standard specifications.

It is important that the user does not modify any luminaire or use them for a purpose, or in an environment for which the luminaires are not designed.

Any modifications may render the luminaires unsafe and will invalidate the warranty and CE compliance of the product.

All luminaires unless otherwise stated are designed for direct connection to a standard mains supply as so indicated on the luminaire. All switching etc. shall comply with BS 5266 part 1 and the latest IEE regulations. Luminaires shall NOT be connected to, or be controlled by an energy management system.

Maintained luminaires should NOT be switched ON/OFF in excess of twice in any 24 hour period, as this can lead to blacking of the lamp and therefore reduce the effectiveness of the luminaire in the case of an emergency.

Installation must only be carried out by a competent electrician and in accordance with the installation and commissioning instructions.

Installation must be carried out in accordance with:

- i) Regulations for Electrical Installation, published by the Institute of Electrical Engineers.
- ii) Requirements of BS 5266 part 1.

Surge suppressers may be required at the point of connection to the supply wiring when installing luminaires to MICC.

Insulation testing should be in accordance with the latest IEE regulations and should not exceed 500V DC between Live and Neutral connected together and Earth.

### 7.2 Remote switching (Maintained)

This facility enables the fluorescent tube to be switched off when the maintained light is not required.

This facility does not affect the operation of the unit in emergency mode should a mains failure occur. When the switched live is energised, the unit will operate in the maintained mode with the tube energised via the mains supply. When the live is de-energised, the luminaire will operate in the non-maintained mode. If this facility is not required, simply linking the switched and unswitched terminals together will cause the luminaire to operate in maintained/sustained mode at all times.

### 7.3 Commissioning/Testing

The unit should be left on charge for a minimum of 24 hours before being tested for its rated duration. After connecting the mains supply check that:

- i) The Red Led is illuminated. This indicates that the battery is being charged correctly.
- ii) The luminaire will energise the lamp under emergency conditions, by removing the mains supply.

b. Routine testing should be carried out in accordance with the instructions as indicated on the test record card. (Which is supplied with each product).

## 7.4 Specification

Lumens Output  
 8W 90 Lumens (3 cell)  
 Battery Data: High temperature NiCd D cell  
 1.2V per cell: 4 Ampere hour rating  
 Input Voltage: 230-240V AC 50Hz

! *Note Lighting levels are only provided to allow checking of correct operation, and determination of correct lighting levels in an escape route can only be made with full photometric data.*

! **BEFORE OBTAINING ACCESS TO TERMINALS, ALL SUPPLY CIRCUITS MUST BE ISOLATED.**

! *This fitting must be electrically earthed.*

Confirm the installation requirements by checking the data provided (especially the AC supply and mode of operation required). Installation must only be carried out by a competent person.

### 7.4.1 Non maintained

A luminaire in which the lamp is lit only under emergency conditions.

### 7.4.2 Maintained

A luminaire in which the lamp is lit either via a separate switched supply or under emergency conditions.

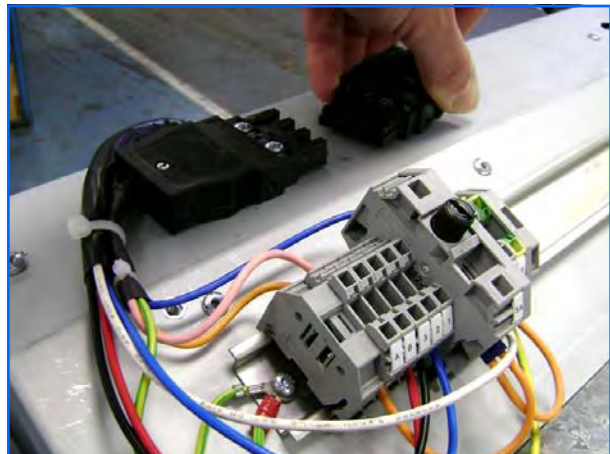
## 7.5 Installation

Connect the mains supplies to the terminal block provided, see connection diagrams. Refer to remote switching instructions for further details.

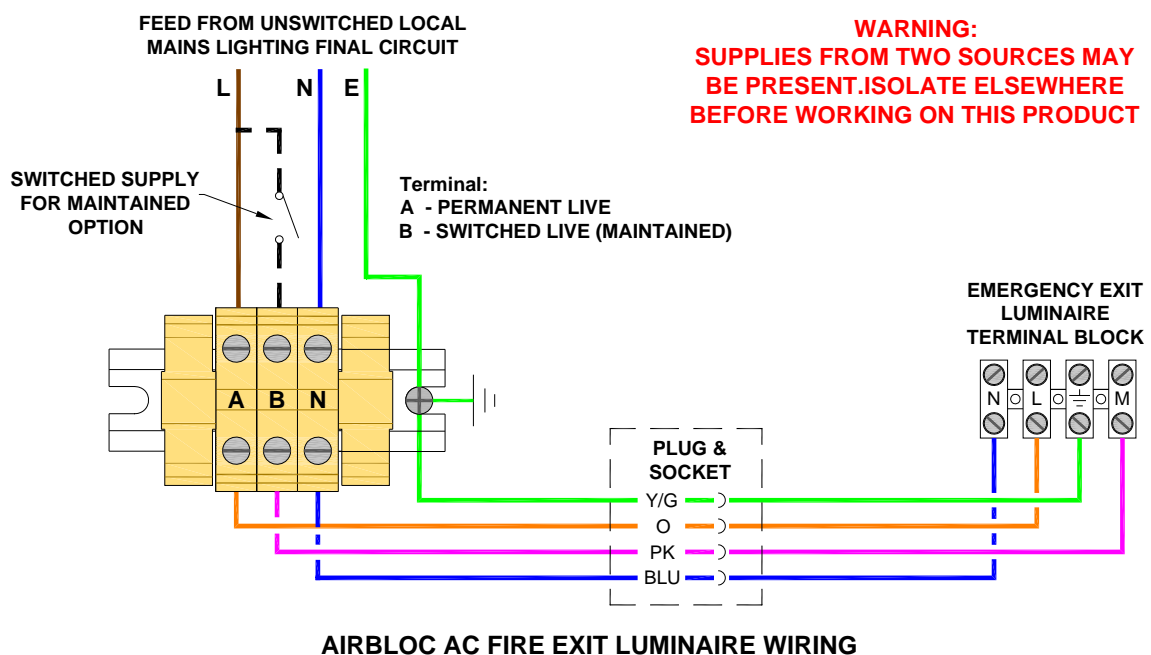
The battery connections are via faston connectors from the PCB to the battery pack. The battery pack should be marked with the date of installation/commissioning.

Refer to general, operating and test Instructions for further details.

*Note: When the live is de-energised, the luminaire will operate in non-maintained mode. If this facility is not required, simply linking the switched and unswitched terminals together will cause the luminaire to operate in maintained mode at all times.*



## 7.6 Wiring Diagram



## 8. Servicing & Maintenance.

**! ALWAYS ENSURE THAT THE MAIN EXTERNAL ELECTRICITY SUPPLY IS SWITCHED OFF BEFORE COMMENCING ANY MAINTENANCE ON THIS HEATER.**

To obtain the best results from the heater, it is essential to avoid the accumulation of dust and dirt within the unit on the air inlet and discharge grilles. For this reason regular cleaning is necessary, paying particular attention to the removal of dirt build up on the rotor blades.

Cleaning of the fan is best carried out with a soft brush.

A single drop of light oil should be applied to the motor bearing from time to time.

The product should be serviced annually. Servicing shall be undertaken by a competent person. Airbloc offer a service facility, call 01384 489700.

### Step 1



Undo screws securing the grille.

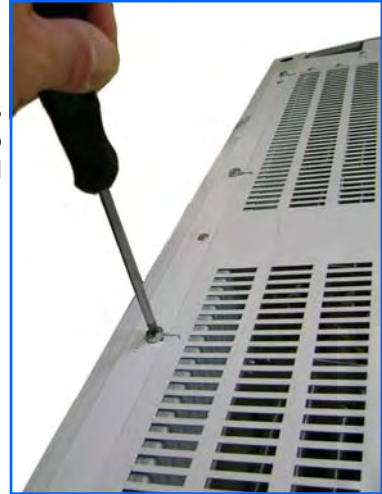
### Step 2



Adjust the grille by turning the screw inside with an allen key.

### Step 3

Remove 4 screws securing the top of the case and remove (not Chassis version)



### Step 4

Slacken two bolts on both ends.



Remove three bolts securing the access plate.

Carefully hinge down the access plate.  
*Note Take the weight as access plate swings down.*

### Step 5

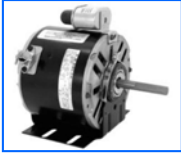

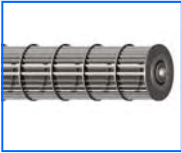


With a soft brush clean away any dust from the motor and elements.

Check all connections and components for soundness or signs of deterioration and replace as necessary.

Re-assemble and test.




## 9. Spare parts

### 9.1 General

	Description	AC1000SE06/ AC1000SE09/ AC1000HE12/ AC1000SW9/ AC1000HW12/ AC1000SA/ AC1000HA	AC1500SE6/ AC1500SE12/ AC1500HE18/ AC1000SW12/ AC1000HW18/ AC1000SA/ AC1000HA	AC2000SE9/ AC2000SE18/ AC2000HE24/ AC2000SW18/ AC2000HW24/ AC2000SA/ AC2000HA
	Motor		100535	
	Contactor (where required)		900078	
	Rotor Left Hand	100539	100540	100541
	Rotor Right Hand	100536	100537	100538
	Thermal cut out (where required)		900001	










### 9.2 AC-ACR-PANEL controller

⚠ Due to the nature of its construction, it is not advisable to repair damaged electronic components on either the AC-ACR base unit or AC-ACR-PANEL programmer

	Program Keypad		AC-ACR-PANEL	
	Base Unit		AC-ACR-PCB	
	Outside Air Sensor		SC-OS	

### 9.3 SmartElec2 controller

! Due to the nature of it's construction, it is not advisable to repair damaged electronic components on either the SmartElec2 base unit or Program panel.

	Description	9/12/18 kW models	24 kW models		Description	9/12/18 kW models	24 kW models
	Program Panel		108221		Cooling Fan	n/a	900330
	Panel P.C.B		SELEC2RP		Outdoor sensor		SC-OS
	Base Unit		SELEC2BU		Data cable c/w plugs	2M SE2-CABLE-2 10M SE2-CABLE-10 20M SE2-CABLE-20 30M SE2-CABLE-30 50M SE2-CABLE-50 100M SE2-CABLE-100	
	Heat Sensor		SELEC2HS				
	Fuse	900471	900472				
	Control fuse		900473				

### 9.4 Heating mediums

Element assembly



Rating	6kW	9kW	12kW	18kW	24kW
SE 1Pha	103713/103714	107819	-	-	-
Length	1.0m/1.5m	2.0m	-	-	-
SE 3Pha	-	100840	100841	100842	-
Length	-	1.0m	1.5m	2.0m	-
HE 3Pha	-	-	100526	100527	100528
Length	-	-	1.0m	1.5m	2.0m

Coil LPHW only



Rating	9kW	12kW	18kW	24kW
SE	101279	101280	101281	-
Length	1.0m	1.5m	2.0m	-
HE	-	100989	100990	100991
Length	-	1.0m	1.5m	2.0m

# 10. Fault Finding.

## 10.1 General

If the air curtain does not operate after running through the detail provided in Section 6, then a suitably competent service engineer should be called to identify the nature of the fault.

*Note The manufacturer operates a service function from the address provided in these instructions.*

All Air Curtains are fitted with fuse protection and motor thermal protection.

Other faults in relation to the element, motor and wiring should be identified using conventional fault finding techniques.

In the event that electrical components are replaced, please ensure that electrical safety checks in accordance with the regulations in force in the country of use are undertaken.

## 10.2 Electrically heated units only.

For the service engineer, please note that there is a thermal cut-out incorporated in the air curtain which needs to be manually reset. The cut-out is located near to the mains terminal block.

Re-setting the thermal cut-out may help to identify the nature of the fault however we do not recommend re-set without a thorough investigation into why the cut-out operated.



fig.11. Thermal cut-out

## 10.3 Electronic Controller.

If the air curtain goes into thermal trip (overheat) the AC-ACR-PANEL keypad displays an 'ERR' code. Refer to air curtain instructions to remedy.

The electronic control base unit is protected from any short circuit on the air sensor or heatsink sensor as the short circuit will cause the temperature to go high and trigger over temperature alarm.

## 10.4 SmartElec2 Controllers.

The SmartElec2 control raises an alarm if any of its inputs are outside their normal working scope. Alarms are displayed on the program panel as a code with a prefix "E". **0 E6** The first number represents the air curtain address. See chart over.

As the alarms are mutually exclusive, the first alarm code displayed on the program panel will stay on until the fault has been cleared.

Apart from the communication failure alarm **0 --** which could be due to a broken connection of the data link and air curtain not found alarm, **E rr** which could be due to incorrect addressing, all other alarms will cause the base unit to switch off the heater output.

The SmartElec2 base unit is protected from any short circuit on the air sensor **0 E1** or heat sink sensor **0 E4** as the error will cause the temperature to rise and trigger over temperature alarm. **0 E1**

There are five basic checks to perform should **0 --** appear on the program panel display. These are as follows:

**1:** Continuity: Use a multimeter to check continuity between each end of all four cores at the plugs


**2:** Short circuit: Use a multimeter to check that there are no short circuits between any of the four cores.

**N.B.** This test should be done with both ends of the cable disconnected to avoid false readings.

**3:** Plugs: Check that the plugs are firmly seated on the circuit board pins in both the program panel and on the base unit.

**4:** Addressing: (Network versions only). If two or more air curtains are networked, check that each base unit has a unique address as described in section 12.4

**5:** Network cables: Ensure that the total run of all cables in the network does not exceed 110m including the cable to the program panel.

If a panel has never before been run, it automatically starts in engineer's mode when first powered-up. To exit this mode, press and hold the  Button.

Alternatively, the engineer's mode automatically self-clears after approximately 10 minutes of non-activity on the switches.

The system can be reset by powering-up the panel whilst holding down the **SELECT** and **—** buttons.

The display shows the 'start' pattern but then goes blank.

Release the buttons where upon the display resumes and the system addressing commences, finding only those air curtains which are actually connected and working.

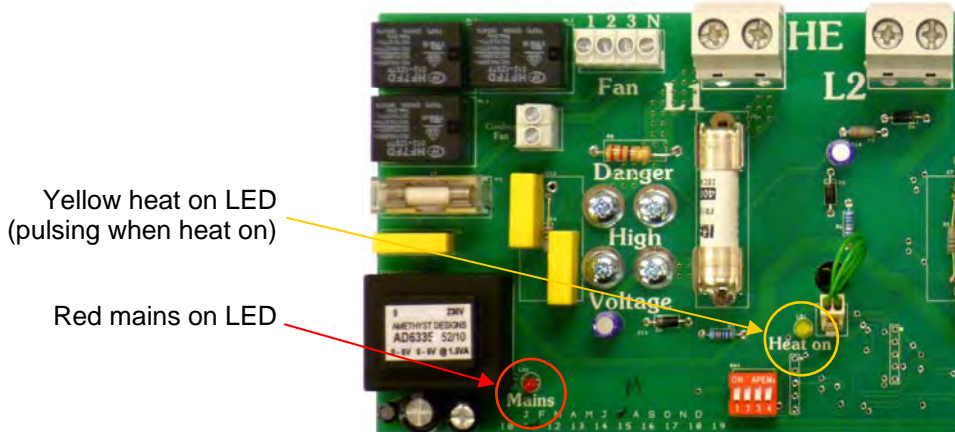
If **E n9** appears on the display, press and hold the **+** button for a few seconds then release. The display will then return to the normal mode.

**10.4.1 SmartElec2 fault codes**

\*NOTE: '#' denotes the controller number.

Code	Description	Symptom	Possible cause	Remedy
#*_ _	COMMUNICATION FAILURE.	No control on faulty unit	Bad data cable connection Damaged cable	Check data cable(s) and plugs Repair/replace damaged cable
# E1	AIR SENSOR TEMPERATURE TOO HIGH or AIR SENSOR FAILURE.	Fan operating, no heat	High ambient air temperature	Check ventilation
			Impeller turning in wrong direction	Check rotation of impeller
		Fan operating, no heat	Motor failure	Check motor & replace if necessary
			Air sensor cable disconnected Air sensor broken	Check cable Replace air sensor
# E3	HEATSINK TOO HOT	Fan operating, no heat	High ambient air/faulty base unit	Replace SmartElec base unit
# E4	HEATSINK SENSOR FAILURE	Fan operating, no heat	Heatsink sensor wiring disconnected/faulty	Check wiring
			Heatsink sensor faulty	Replace SmartElec base unit
# E5	EXTERNAL TEMPERATURE SENSOR FAILURE	Unit runs, but no external temperature control	External temperature sensor faulty	Replace sensor
			External temperature sensor wiring faulty	Repair/replace faulty wiring
# E6	OVERHEAT THERMOSTAT OPEN CIRCUIT	Fan operating, no heat	Overheat thermostat open circuit	Reset/replace overheat thermostat

**10.4.2 SmartElec base unit LED indicator location/function:**



# 11. Parts replacement.

## 11.1 Rotor and motor replacement.

**Warning**  
Ensure electrical power is isolated from the product.

For access follow steps 1 - 4 as stated in Section 8

**Step 1**  
Remove 3 screws securing fan bearing plate to access panel.

Carefully remove plate with bearing housing from rotor bearing.

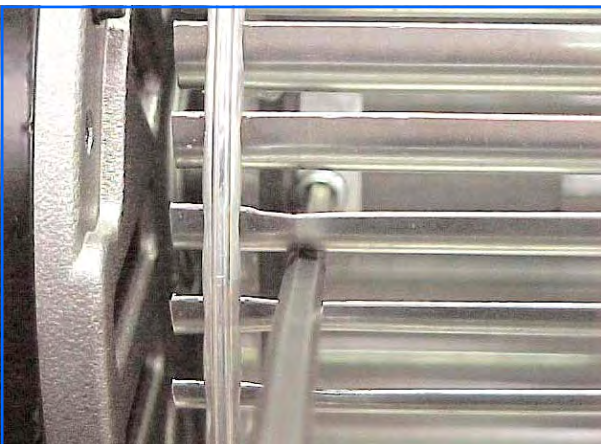


### Step 2



Slacken the grub screw securing rotors to the motor shaft, remove rotor.

Repeat steps 1 - 2 for opposite rotor.



### Step 4



Disconnect the wires from the motor to the mains terminal rail.

### Step 5



Remove the bolts securing the motor to the chassis.

Replace motor as required.

### Step 6

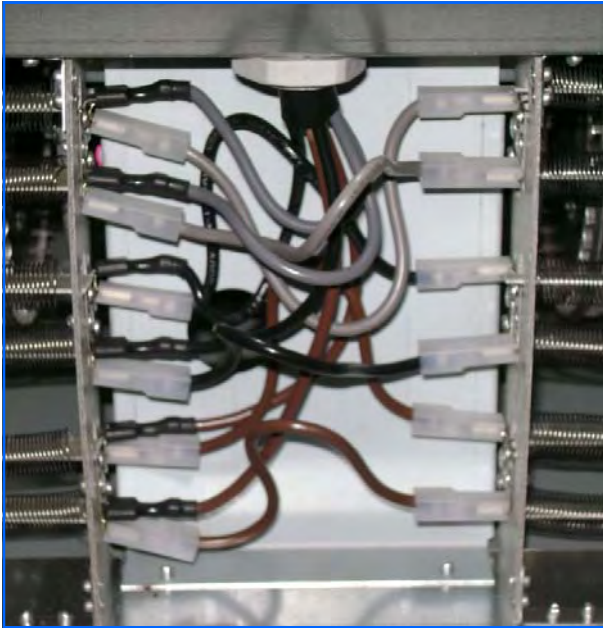
Refit in reverse of previous steps and test the performance of the product.

## 11.2 Element replacement.

For access follow steps 1 - 4 as stated in Section 8

### Step 1.

Carefully remove connections to the elements, noting wiring configuration.



### 11.3 LPHW coil replacement.

For access follow steps 1 - 4 as stated in Section 8

#### Step 1

Disconnect flow connections with appropriate tools.

#### Step 2.

Lift out element cartridge, replace as required.

Refit in reverse order (including (motor refit on previous page)

Test performance of the product.

#### Step 2.

Remove two bolts securing elements.



#### Step 3.

Lift out element cartridge, replace as required.



Refit in reverse order (including (motor refit on previous page)

Test performance of the product.



## 12. User Instructions.

fig.12. AC-ACR-PANEL Programmer



### 12.1.1 Keypad Buttons

The **SELECT** button will allow you to navigate.

The **+** button will allow you to increase the setting.

The **-** button will allow you to decrease the setting.



### 12.1.2 Operation

On first power up, the display panel will have the following default settings:

- F. 0 (no fan)
- H. 0 (no heat)
- 1. 16 (°C. Heat set point - Auto mode only)
- 2. 7 (°C. half heat set point - Auto mode only)
- D. 2 (fan speed in door switch mode)

**Note:** Subsequent power ups will retain any entered settings in the display panel internal memory.

Press the **+** or **-** buttons to toggle between the 'F' (Fan), 'H' (Heat) and On/Off Parameters.

Prefix 'F' denotes the **FAN SPEED**. This can be either 1: slow ; 2: medium or 3: fast speed. 0 setting denotes the unit is **OFF**.

To alter the current speed, press the **SELECT** button. The value will start flashing.

Press the **+** or **-** buttons to increase/decrease the desired setting.

Press the **SELECT** button to confirm new setting. A delay of 7 seconds will return to the original display.

Prefix 'H' denotes the **HEAT** setting. This can be either 1: low heat; or 2: high heat. 0 setting denotes the unit is set at fan only.


To alter the current setting, press the **SELECT** button. The value will start flashing.


Press the **+** or **-** buttons to increase/decrease the desired setting.


Press the **SELECT** button to confirm new setting. A delay of 7 seconds will return to the original display.




The next parameter will either turn the unit On or Off.


To turn the unit Off, press the  button. 'On' will start flashing.

Press the  button. 'Off' will start flashing.

Press the  button to confirm new setting.

To turn the unit On, press the  button. 'Off' will start flashing.

Press the  button to alter to 'On'.


Press the  button to confirm new setting. A delay of 7 seconds will return to the 'F' Fan parameter.






### 12.1.3 Engineers settings



#### 12.1.3.1 Auto Mode


The controller can be set to automatic control only when used in conjunction with an optional outside sensor.

To access the engineers setting, first ensure that the display is in the (H) HEAT parameter. Press and hold the  button for 5 seconds. Set point '1' will appear.




*If the outside air temperature is above this value, there is no heat power. If the outside temperature falls below this value but is above set point 2, then the heat will be at half power. (Range: 0 - 30 degrees).*


To alter the setting, press the  button then the  or  buttons to increase/decrease the desired setting.

Press the  button to confirm new value and use the  button to move to the next setting. (A delay of 7 seconds will return to the original display.)


If you have previously pressed the  button, Set point '2' will appear.

*If the outside air temperature falls below this value, the heat will be at full power. If the outside temperature is above this value but is below set point 1, then the heat will be at half power. (Range: 0 - 30 degrees)*


To alter the setting, press the  button then the  or  buttons to increase/decrease the desired setting.



Press the  button to confirm new value.





Press the  button, setting "A.Of" will appear.

*This setting will enable the Auto Mode. (Range: On/Off)*

To alter the setting, press the  button then the

 or  buttons to toggle between the "A.Of" and "A.On" modes. "A.On" enables the air curtain to run under automatic control from the optional outdoor sensor. "A.Of" enables the air curtain to run under normal control.


*To return to the engineering setting mode press and hold the  button for 5 seconds.*

*To return to normal operating mode press and hold the  button for 5 seconds.*







### 12.1.3.2 Door Switch Mode

The controller can be set to a preset fan speed when the door opens. This function can only be used in conjunction with a door switch.

To access the engineers setting, first ensure that the display is in the (F) FAN parameter. Press and hold the  button for 5 seconds. Setting 'd' will appear.

*The air curtain operates as normal under the program of the Fan and Heat settings. As the door opens the air curtain changes state to the settings preset in this mode. As the door closes, the air curtain returns to normal. (Range: 1: slow ; 2: medium or 3: fast speed. 0 setting denotes the unit is **OFF**.)*

To alter the setting, press the  button then the  or  buttons to increase/decrease the desired setting.

Press the  button to confirm new setting. A delay of 2 seconds will return to the original display.



**Note: All air curtains connected within the network system will operate in unison under the user settings of the single keypad.**

**Any air curtain can respond to optional circuits i.e. External switch (BMS); or Door switch or Internal/external sensors, ON AN INDIVIDUAL BASES.**

## 12.2 Option SmartElec2 Controller



fig.13. SmartElec2 Programmer

### 12.2.1 Keypad buttons



The buttons have the following functions:



Press the select button to allow navigation.



Press the + button to increase a setting.



Press the - button to decrease a setting.


### 12.2.2 Keypad display

#### 12.2.2.1 Normal mode displays

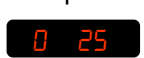
Display	Meaning
- -	First power up
E rr	No air curtains found
0 25	Curtain address and temperature set point

#### 12.2.2.2 Normal Operation


During normal operation mode the display is dimmed.

Pressing the  button, will put the panel into active mode. If no button is pressed for several seconds the display reverts to normal mode.


During normal operation the unit will display for example:

 where '0' is the curtain address, and '25' the temperature measured for the unit.

Where multiple air curtains exist in a network, the display scrolls through each unit in turn, changing approximately once every second.

If the air curtain is in operation and under heat demand, a 'decimal point' is shown after the air curtain address. 



#### 12.2.3 OFF mode.


During normal operation, press and hold the  button for approximately two seconds. The display blanks until you release the button. The heating and fans are now turned off. Releasing the button in less than this time and the action has no effect.




Where multiple air curtains exist in a network, this action turns off all air curtains.

### 12.2.4 Settings Mode


#### 12.2.4.1 Activate settings display

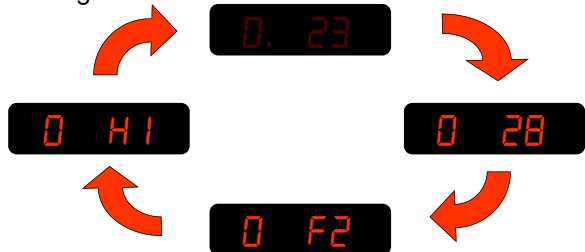
To enter the Settings mode press the  button. This will illuminate the screen. Press the  button till the desired setting is shown.

By pressing the  button it will also advance to the next setting.

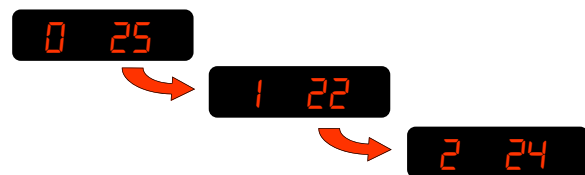
Note: If a setting has been altered by using the  or  buttons, it must be confirmed by pressing the  button.


#### 12.2.4.2 Settings displays

Press the  button to advance through the settings.




Where multiple air curtains exist in a network and controlled from a single keypad, these will be detected and displayed in turn, for example:





Any air curtain in the network can be accessed by pressing the  button when it's address appears on the display. The settings can then be accessed as previously described.

## 12.2.5 Set-up configurations

### 12.2.5.1 Set fan speed

Once the display becomes illuminated press the  button once. Display shows the fan speed.


Press  to increase fan speed.


Press  to decrease fan speed.


Three speeds and an 'off' setting are available:


 Speed 1    Speed 2  
 Speed 3    Fan 'off'

### 12.2.5.2 Set heat


Press the  button again Display shows the heat setting.


Press  to set heat 'on'.


Press  to set heat 'off'.


If no button pressed for 2 seconds, display will revert to normal user. eg 

### 12.2.5.3 Set temperature

Press the  button once to allow changes to be made.


Press  to increase temperature set point.  
(max 35°C)


Press  to decrease temperature set point.  
(min 16°C)

Display shows for example: 

### 12.2.5.4 Networked air curtains




*Where multiple air curtains exist in a network and controlled from a single keypad, these will be detected and displayed in turn, for example:*




*Any air curtain in the network can be accessed by pressing  when it's address appears on the display. The settings can then be changed as previously described.*



## 12.2.6 Engineers settings


Other options are available in engineer's mode.

To access the engineers mode *either*:  
press and hold the  button for a few seconds until the display goes blank, then press  briefly. The display will show 

or

Power-up the system with the  and  buttons pressed and release when the display goes blank the display will show 

As in normal mode, Engineers set-up mode is started by pressing the  button whereupon the display will illuminate. Advance through the normal modes settings of temperature, fan and heat by pressing the  button.





Pressing the  button again advances to further options to allow other settings of the system. The engineers set-up options listed herewith depend various factors e.g. optional door switch, multiple air curtains etc.





*Notes: If a panel has never before been run, it automatically starts in engineer's mode when first powered-up.*

*Engineer's mode automatically self-clears after approximately 10 minutes of non-activity on the switches.*

### 12.2.6.1: Door link settings:



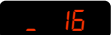
This provides an alternative fan speed and heat setting which is activated only when the door link is open circuit.

The fan speed is accessed by pressing the  button until the display shows:  Use the  and  buttons to change the setting.

Display	Meaning
	Fan off
	Fan speed 1
	Fan speed 2
	Fan speed 3




### 12.2.6.6 Temperature limits



This function is accessed by pressing the  button until the display shows  and  respectively i.e. maximum and minimum set limits for set temperature.

Use the  and  buttons to change to the desired limit temperature settings.

The maximum (default 35°C) may be set anywhere between the current minimum and 50°C, and the minimum, (default 16°C) may be set anywhere between 3°C and the current maximum.



To exit the engineers mode press and hold the  button for a few seconds.

### 12.2.7 Power-up Manual Reset

The system can be reset by powering-up the panel whilst holding down the  and  buttons.

The display shows the 'start' pattern but then goes blank.

Release the buttons where upon the display resumes and the system addressing commences, finding only those air curtains which are actually connected and working.

If  appears on the display, press and hold the  button for a few seconds then release. The display will then return to the normal mode.

### 12.2.8 Air curtain addressing

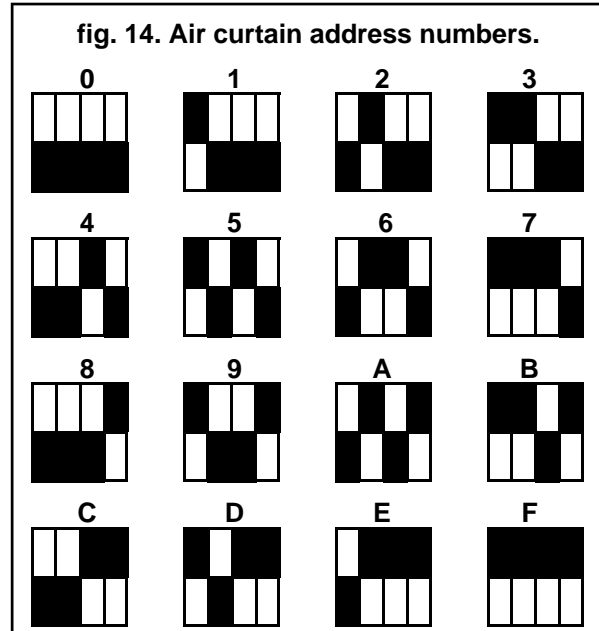
All air curtains work on an address address to communicate with the keypad and are supplied with an default address of '0'.

Where multiple air curtains exist in a network they must be re-addressed using a unique address (0-9/A-F). This is achieved using a 4 way bitswitch mounted on the base unit PCB (see photo opposite)

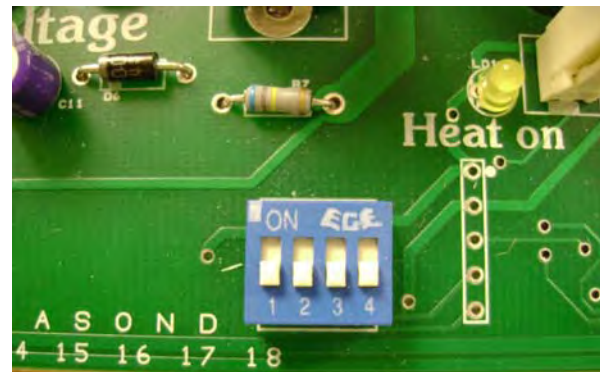
The keypad will check all addresses on first power up and this is displayed as the first digit on the display (in a network set up, all addressees will be viewed in rotation).

*Note: If any address is altered after initial power up or an air curtain removed after initial installation, the keypad will also retain the original address although unable to respond.*

*To remove this unwanted address(s) follow the details in 12.2.7 Power-up Manual Reset.*

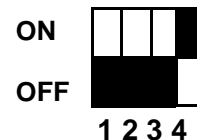


**fig. 15. Bitswitch position**

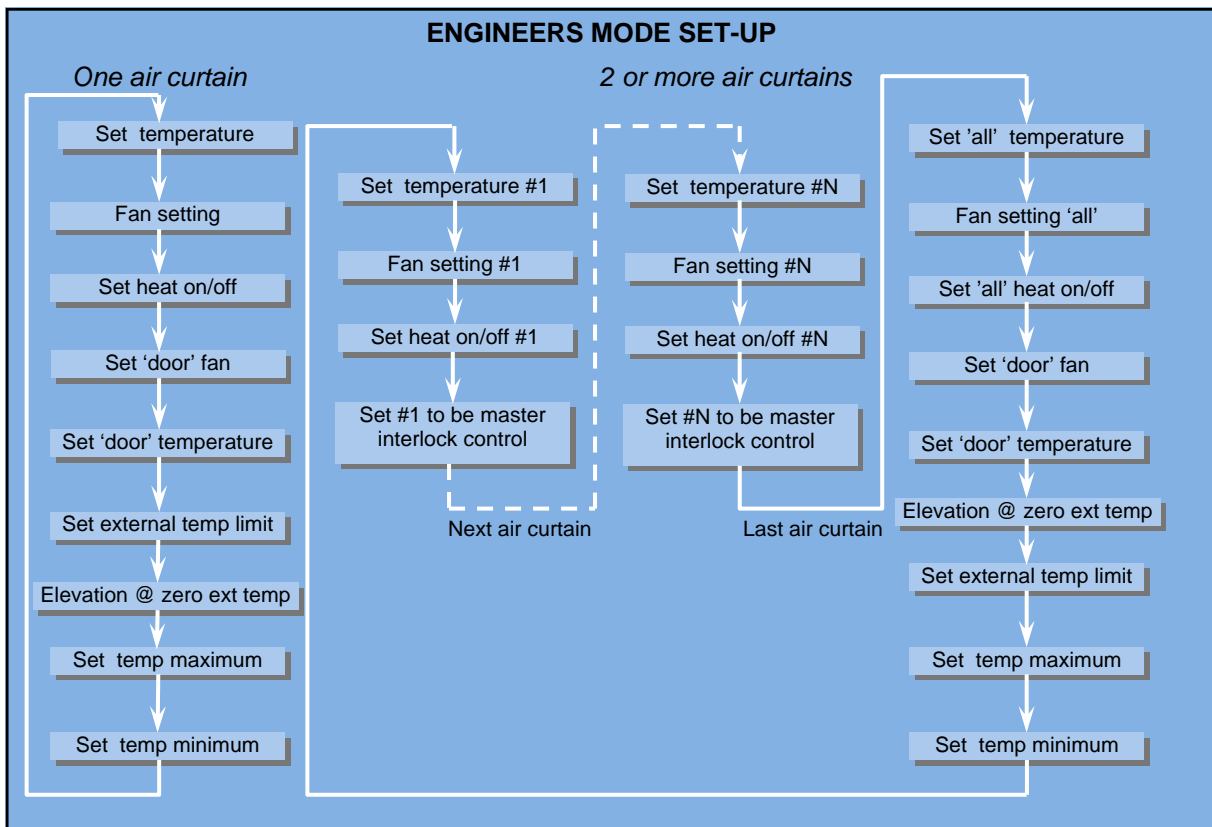
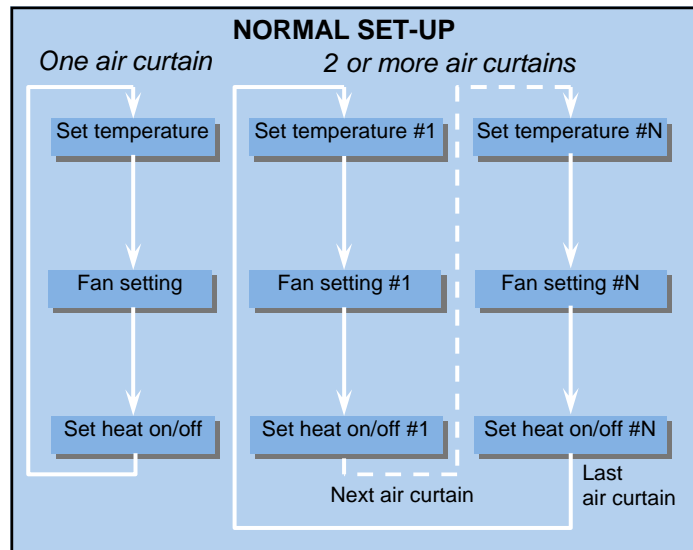
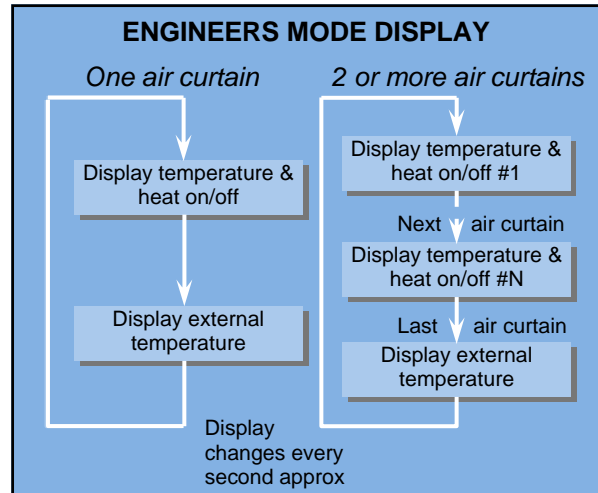
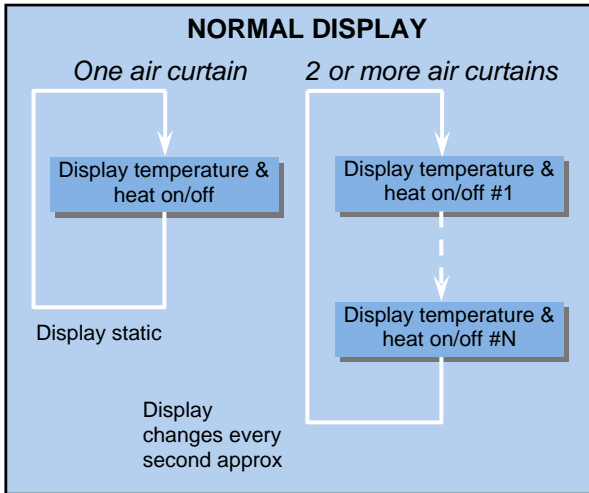


The black shaded areas represent the switch position.

The example shows the **ON** air curtain set to No.8.



## 12.2.9 Keypad sequences



# AmbiRad Group

Heating and Ventilation Solutions

**AMBIRAD** **AIRBLOC** **NORDAIRNICHE** **BENSON**

A Thomas & Betts Company. Registered in England No. 1390934. Registered office: 27/28 East Castle Street, London.

AmbiRad UK is a registered trademark of AmbiRad Limited. Because of continuous product innovation, AmbiRad reserves the right to change product specification without due notice.

**AMBIRAD LIMITED**  
Fens Pool Avenue  
Brierley Hill  
West Midlands DY5 1QA  
United Kingdom

Tel: **01384 489 700**  
Fax: **01384 489 707**

[ambiradsales@tnb.com](mailto:ambiradsales@tnb.com)  
[www.ambiradgroup.co.uk](http://www.ambiradgroup.co.uk)